



Tegam Incorporated is a designer, manufacturer and world-wide marketer of electronic test equipment that tests, measures, sources and simulates electrical parameters. Tegam has grown through a healthy mix of new product development and acquisition. At Tegam, we also manufacture the standards that you have come to know and trust. For example:

- Scope Calibration and Modular Products...*formerly manufactured by Tektronix*
- Metrology Standards and Systems...*formerly manufactured by Electro-Scientific Industries & Gertsch*
- Production Test Instruments...*formerly manufactured by Electro-Scientific Industries*
- EMC/EMI Products...*formerly manufactured by Stoddart and Singer*
- Handheld Test Instruments...*formerly manufactured by Keithley Instruments*

Call us at 800-666-1010 to talk with one of our technical support or customer service representatives for additional information on any of these fine products.

Microprocessor Digital Thermometer

Instruction Manual
Models 819, 820 and 821



TEN TEGAM WAY • GENEVA, OHIO 44041
PHONE 440-466-6100 • FAX 440-466-6110

Publication Date: May 2004
Document Number: 819-901-01B Rev. M

WARRANTY

Tegam, Inc. warrants this product to be free from defects in material and workmanship for a period of three years from date of shipment. During the warranty period, we will at our option, either repair or replace any product that proves to be defective.

Tegam, Inc. warrants the calibration of this product for a period of two years from date of shipment. During this period we will recalibrate any product that does not conform to the published accuracy specification.

To exercise this warranty, contact Tegam, Inc., Ten Tegam Way, Geneva, Ohio 44041/FAX (440) 466-6100/(440) 466-6100, M-F, 8 a.m. - 5 p.m. ET. You will be given prompt assistance and return instructions. Send the instrument, transportation prepaid, to the indicated service facility. Repairs will be made and the instrument returned, transportation prepaid. Repaired products are warranted for the balance of the original warranty, or at least 90 days, whichever is longer.

LIMITATION OF WARRANTY

Tegam, Inc. warranty does not apply to defects resulting from unauthorized modification or misuse of any product or part. This warranty also does not apply to fuses, batteries, or damage from battery leakage.

This warranty is in lieu of all other warranties, expressed or implied, including any implied warranty of merchantability or fitness for a particular use. Tegam, Inc. shall not be liable for any indirect, special or consequential damages.

STATEMENT OF CALIBRATION

This instrument has been inspected and tested in accordance with specifications published by Tegam, Inc.

The accuracy and calibration of this instrument are traceable to the National Institute of Standards and Technology through equipment which is calibrated at planned intervals by comparison to certified standards maintained in the Laboratories of Tegam, Inc.

NOTES

TABLE OF CONTENTS

General Information	2
Specifications	2
Difference Specifications	4
Features	5
Manual Addenda	5
Unpacking and Inspection	5
Safety Information	6
Safety Precautions	6
Battery Installation/Replacement	8
Memory Backup	10
Operation with Rechargeable Battery	10
Operating Instructions	10
1. Diagnostics	10
2. Display Annunciators	11
3. Function Keys	13
Service Information	18
1. Calibration Procedure	18
2. Disassembly Instructions	19
3. Mechanical Parts Diagram	21
Warranty	Back Cover
Limitation of Warranty	Back Cover
Statement of Calibration	Back Cover

GENERAL INFORMATION

This manual provides information on the use of three digital handheld thermometers. Functional features both common and unique to each model are described.

All three models are microprocessor based, and provide accurate and reliable operation. They function with the most popular thermocouples; types K, J, and T. A variety of features in these projects enhance their versatility, while simplifying operation.

It is recommended that you read this manual thoroughly, especially the sections on safety, prior to operating these instruments.

SPECIFICATIONS

THERMOCOUPLE INPUTS: 2 (T1, T2) miniature TC connectors.

Accepts male miniature and subminiature TC connectors.

THERMOCOUPLE TYPES: K, J, T

READOUT: T1, T2, T1-T2, and SCAN (T1, T2, T1-T2).

ACCURACY: (18°C to 28°C ambient, 2 years, excludes thermocouple error).

TC Type	Range	Resolution	Accuracy (T1,T2)	Accuracy (T1-T2)	Extended Temp. Range Acc'y (T1,T2) Typ.
K	0°C to 1372°C	0.1/1°C	±(0.1%rdg + 0.6°C)	Acc'y (T1) + Acc'y(T2)	-200°C to -250°C,±(3°C)
	32°F to 2502°F	0.1/1°F	±(0.1%rdg + 1.0°F)	Acc'y (T1) + Acc'y(T2)	-328°F to -418°F,±(5°F)
	-200°C to 0°C	0.1/1°C	±(0.3%rdg + 0.6°C)	Acc'y (T1) + Acc'y(T2)	
	-328°F to 32°F	0.1/1°F	±(0.3%rdg + 1.0°F)	Acc'y (T1) + Acc'y(T2)	
J	0°C to 760°C	0.1/1°C	±(0.1%rdg + 0.6°C)	Acc'y (T1) + Acc'y(T2)	—
	32°F to 1400°F	0.1/1°F	±(0.1%rdg + 1.0°F)	Acc'y (T1) + Acc'y(T2)	—
	-210°C to 0°C	0.1/1°C	±(0.3%rdg + 0.6°C)	Acc'y (T1) + Acc'y(T2)	—
	-346°F to 32°F	0.1/1°F	±(0.3%rdg + 1.0°F)	Acc'y (T1) + Acc'y(T2)	—
T	0°C to 400°C	0.1/1°C	±(0.1%rdg + 0.6°C)	Acc'y(T1) + Acc'y (T2)	-200°C to -250°C,±(3°C)
	32°F to 752°F	0.1/1°F	±(0.1%rdg + 1.0°F)	Acc'y(T1) + Acc'y (T2)	-328°F to -418°F,±(5°F)
	-200°C to 0°C	0.1/1°C	±(0.3%rdg + 0.6°C)	Acc'y (T1) + Acc'y (T2)	
	-328°F to 32°F	0.1/1°F	±(0.3%rdg + 1.0°F)	Acc'y (T1) + Acc'y (T2)	

REPEATABILITY: ±0.2°C typical for 1 week at constant ambient temperature.

TEMPERATURE COEFFICIENT: 18°C to 28°C; included in accuracy specification. From 0°C to 18°C, and 28°C to 50°C; less than ±(0.02% rdg + 0.1°C)/°C.

ENVIRONMENTAL LIMITS FOR OPERATING: 0°C to 50°C, less than 80% relative humidity (R.H.) up to 35°C; reduce R.H. limit by 3%/°C from 35°C to 50°C.

ENVIRONMENTAL LIMITS FOR STORAGE: -35°C to 60°C, less than 90% relative humidity (R.H.) up to 35°C; reduce R.H. limit by 3%/°C from 35°C to 60°C.

INPUT CURRENT: 50 nA typical.

READING RATE: (T1, T2, T1-T2); 1 reading/second typical, all parameters.

NOTES

NOTES

MAXIMUM COMMON MODE VOLTAGE: 42V peak to earth.

POWER: 9 volt transistor battery (NEDA 1604).

BATTERY LIFE, CONTINUOUS: 50 hrs typical, carbon-zinc; 100 hrs typical, alkaline; 200 hrs typical, lithium; 15 hrs typical, Ni-Cd (rechargeable).

BATTERY INDICATOR: Display indicates BAT when less than 10% of life remains.

DISPLAY: 5 digit LCD, 0.4" height. Polarity indication, and decimal point.

Annunciators

- Readout Parameter: T1, T2, T1-T2, SCAN
- Record Parameter: MIN or MAX (when viewing recorded data).
- Readout Scale: °F, °C
- TC Type: K, J, T
- Hold (when activated)
- Reading Trend: up-arrow for increasing readings, down-arrow for decreasing readings. Both arrows on for stable reading.
- Record MIN/MAX readings for T1, T2, and/or T1-T2; Flashing annunciator indicates data being collected. Steady annunciator indicates data available, but not being up-dated.

KEYPAD: 9 momentary switches with tactile feedback select;

- Power ON/OFF
- Readout: T1, T2, T1-T2, or SCAN
- TC type: K, J, T
- Readout scale: °F/°C
- Resolution: 0.1°/1°
- Display Hold
- Record MIN/MAX
- View MIN/MAX
- Stop recording MIN/MAX (first keystroke), clear recorded MIN/MAX (second keystroke)

POWER OFF CONFIGURATION RETENTION: Instrument retains last selected;

- Readout: T1, T2, T1-T2, SCAN
- TC type: K, J, T
- Resolution: 0.1°/1°
- Scale: °F/°C

DIAGNOSTICS: Display codes indicate the following conditions:

- Low Battery: 'BAT'
- Open Thermocouple(s): 'OPEN'
- Invalid Keypad Entry: Momentary 'E-1'
- Temperature Reading exceeds TC Rating: 'E-2'
- Internal Hardware Fault: 'E-3' (consult factory)
- LCD Test: During power-up, all segments/annunciators turned on momentarily.

ELECTROMAGNETIC COMPATIBILITY: Add $\pm 0.5\%$ of range to accuracy specifications for RF fields up to 1 volt/meter. Accuracy not specified for fields greater than 1 volt/meter.

DIMENSIONS, WEIGHT: 7.0" x 2.9" x 1.1". Net weight 10 oz.

DIFFERENCE SPECIFICATIONS

MODEL 819:

THERMOCOUPLE INPUTS: 1

DISPLAY: 5 digit LCD, 0.4" height. Polarity indication, and decimal point.

Annunciators

- Readout Scale: °F, °C
- TC Type: K, J, T
- Hold (when activated)

KEYPAD: 5 momentary switches with tactile feedback select;

- Power ON/OFF
- TC type: K, J, T
- Readout scale: °F/°C
- Resolution: 0.1°/1°
- Display Hold

POWER OFF CONFIGURATION RETENTION: Instrument retains last selected;

- TC type: K, J, T
- Resolution: 0.1°/1°
- Scale: °F/°C

MODEL 820:

THERMOCOUPLE TYPES: K, J

3. MECHANICAL PARTS DIAGRAM

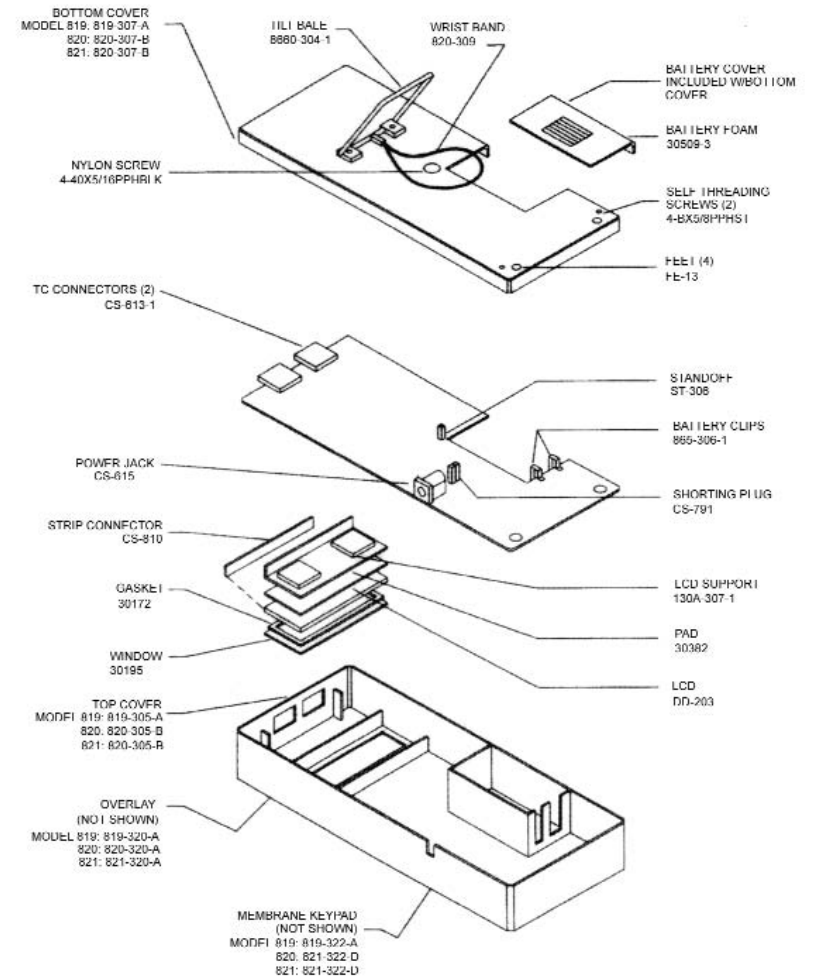

Re-assemble the instrument by following the reverse of the above procedure.

CAUTION

Do not use excessive torque when re-installing the nylon machine-screw into the rear case. Excess torque will damage the part.

WARNING

Do not substitute a metal part for the nylon machine-screw. Doing so will degrade the electrical isolation of the instrument.

FEATURES

- Temperature trend indication (rising, falling, or stable)
- Full range resolution of 0.1 degree
- Work with thermocouple types K, J and T
- Keypad selectable °F or °C
- Two probe inputs (for two point temperature measurements)
- Calculates and displays temperature difference between the two probe inputs
- Maximum and minimum temperature storage
- Dust proof, splash proof, drop proof construction
- Built-in tilt stand/hanger for bench use or hands free field measurements
- User friendly function programming
- Performs self diagnostic test and displays error readout
- Retains function settings, even when turned off
- Low battery and open sensor indication
- Input data scan and display hold modes

MANUAL ADDENDA

Improvements or changes to this manual will be explained on an addendum included with the instrument. All change information should be incorporated immediately into the appropriate places in the manual.

UNPACKING AND INSPECTION

Each instrument is inspected both mechanically and electrically before shipment. Upon receiving your instrument unpack all items from the shipping container and check for any obvious damage that may have occurred during transit. Report any damage to the shipping agent. Retain and use the original packing materials if reshipment is necessary.

The following items are included with every shipment.

1. Digital Thermometer
2. Instruction Manual
3. Model 8712 Thermocouple Sensor(s)
4. Part No. 820-309 Wrist Strap
5. 9V Battery (NEDA 1604)
6. Optional accessories as requested.

SAFETY INFORMATION

SAFETY SYMBOLS AND TERMS

The symbol  on the instrument denotes that the user should refer to the operating instructions.

The **WARNING** used in this manual explains dangers that could result in personal injury or death.

The **CAUTION** used in this manual explains hazards that could damage the instrument.

SAFETY PRECAUTIONS

WARNING

These instruments are intended for use by qualified personnel trained in the safe operation of electronic testing equipment. Read the instruction manual thoroughly before using, to become familiar with the instrument's operations and capabilities.

WARNING

Do not touch a temperature probe sheath when measuring excessively high or low temperatures, or toxic substances.

WARNING

Do not attempt to measure temperatures beyond the range of the probe being used. Probe damage or personal injury could result from exceeding a probe's maximum temperature rating.

WARNING

The American National Safety Institute (ANSI) states that a shock hazard exists when probes or sensors are exposed to voltage levels greater than 42VDC or 42V peak AC. Do not use this instrument where voltages at the measurement surface exceed these levels.

12. Wait for U.U.T. readout to stabilize, then press HOLD key once, and wait a few seconds. U.U.T. should read $32.0^{\circ}\text{F} \pm 0.5^{\circ}\text{F}$, type J.
13. Set calibrator output to 1400°F , type J.
14. Wait for U.U.T. readout to stabilize, then press HOLD key once, and wait a few seconds. U.U.T. should read $1400^{\circ}\text{F} \pm 1.0^{\circ}\text{F}$, type J.
NOTE: On Model 820, go to step 21 to complete calibration. On Models 819 and 821, continue calibration at step 15.
15. Replace type J cable with Type T.
16. Set calibrator output to 32°F , type T.
17. Wait for U.U.T. readout to stabilize, then press HOLD key once, and wait a few seconds. U.U.T. should read $32.0^{\circ}\text{F} \pm 0.5^{\circ}\text{F}$, type T.
18. Set calibrator output to 750°F , type T.
19. Wait for U.U.T. reading to stabilize, then press HOLD key once, and wait a few seconds. U.U.T. should read $750.0^{\circ}\text{F} \pm 1.0^{\circ}\text{F}$, type T.
20. Press HOLD key one last time. Wait for HOLD annunciator to show on readout. (Indicates that calibration data is stored in EEPROM.)
21. Carefully remove battery cover while holding battery in place. Loss of battery power at this time will cause loss of calibration data.
22. Remove back cover while holding battery in place.
23. Re-install shorting-plug J1 to write-protect EEPROM.
24. Turn off U.U.T. Replace rear cover and battery cover. Calibration is complete.

2. DISASSEMBLY INSTRUCTIONS

Before opening the case, remove all input/output connections. This includes input sensors, calibration cables, and the optional battery charger.

Turn the instrument face down, and remove the three Phillips head screws from the rear cover. Lift off the rear cover. The circuit board can be lifted from the front case after removal of the hexagonal-standoff.

NOTE: Be sure to keep the case down during this last step. Otherwise, the LCD and its associated hardware may fall free and break.

SERVICE INFORMATION

WARNING

All service information is intended for qualified electronic maintenance personnel only.

1. CALIBRATION PROCEDURE

Test Equipment Required:

1. Thermocouple calibrator (Tegam 855, or equivalent).
2. Thermocouple cable for each thermocouple type handled by unit under test (U.U.T.):
 - Type K
 - Type J
 - Type T

Ambient Conditions:

Units should be calibrated at an ambient temperature of 23°C ±1°C, with relative humidity less than 80%. Avoid air currents and heat sources that can disturb the thermal equilibrium of the U.U.T.

Procedure:

1. Turn OFF U.U.T.
2. Remove rear cover. Refer to Disassembly Instructions.
3. Remove shorting-plug J1 from circuit board. Refer to Mechanical Parts Diagram for location (P/N CS-791).
4. Replace rear cover. Reinstall battery. Turn on U.U.T.
5. Connect input of U.U.T. to the thermocouple calibrator with a type K cable. Use input T1 on Models 820 and 821.
6. Set calibrator output to 32°F, type K.
7. Wait for U.U.T. readout to stabilize, then press HOLD key once, and wait a few seconds. U.U.T. should read 32.0°F ±0.5°F, type K.
8. Set calibrator to 2500°F, type K.
9. Wait for U.U.T. readout to stabilize, then press HOLD key once, and wait a few seconds. U.U.T. should read 2500.0°F ±1.0°F, type K.
10. Replace type K cable with type J.
11. Set calibrator output to 32°F, type J.

WARNING

Do not substitute a metal part for the nylon screw in the rear case. Doing so will degrade electrical isolation of the case.

WARNING

The battery is accessible through a cover on the back of the instrument. To avoid electrical shock hazard, disconnect all temperature probes and sensors and turn the unit off before removing the cover.

WARNING

Never use this instrument or any probe or sensor inside a microwave oven.

CAUTION

Avoid making sharp bends in probe or sensor lead wires. Bending lead wires at a sharp angle can damage the wire causing probe failure.

CAUTION

When using both thermometer inputs, and voltage differential exists between the two measurement points, at least one probe should be electrically insulated. If not, ground-loop current can flow through the thermocouple leads causing measurement error or instrument damage.

BATTERY INSTALLATION/REPLACEMENT

A 9V battery is supplied with the instrument but not installed. Read the following installation instructions before attempting to install or remove the battery.

WARNING

Turn the unit off and disconnect any input connections before replacing the battery. Put the cover back into place on the battery compartment before resuming use of the instrument.

1. Remove the cover from the battery compartment by sliding it off in the direction of the arrow located on the battery cover.
2. Remove the old battery.
3. Place the new battery in the battery compartment. Be sure to observe proper polarity.
4. Re-install the battery cover before resuming use of the instrument.

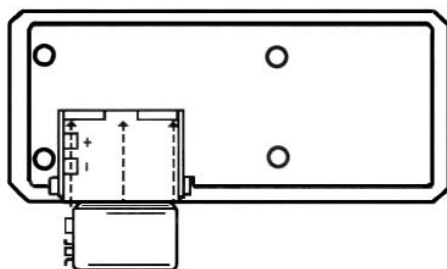

Figure 1. Battery Installation

NOTES:

- Less than 10% of battery life remains when the BAT annunciator turns on.
- If the instrument is going to be stored for a long period of time or in a high temperature environment, remove the battery to prevent leakage damage.
- After a new battery is installed, allow approximately 30 seconds for reading stabilization the first time the instrument is turned on.



Recording in one or more of the three measurement modes T1, T2, and T1-T2 can be stopped with this key. Before pressing CLR this key, select the appropriate mode. When MIN/MAX data collection is stopped, the corresponding REC annunciator will stop flashing, but will remain on (to indicate that MIN/MAX data has been saved for viewing). Recording can be re-started any-time without loss of data with the REC key. See REC.

If the STOP/CLR key is pressed again (after stopping data recording), MIN/MAX data for the corresponding measurement mode is cleared, and the REC annunciator is turned off.

NOTES:

- MIN/MAX data is erased when the thermometer is turned off.
- Record configurations are not saved during power-off.
- STOP/CLR function cannot be performed while the readout is in the SCAN mode. Select T1, T2, and/or T1-T2 modes before attempting to stop recording or clear data.
- The STOP/CLR key must be pressed twice to clear recorded data, and will only clear data in the TC mode that is active when the key is pressed.

VIEW

With the thermometer in either the T1, T2, or T1-T2 mode, corresponding MIN/MAX data can be viewed. To view MIN/MAX data, first select T1, T2, or T1-T2. Then press the VIEW key to read the MAX temperature. A second press of the VIEW key will display the MIN temperature. At the third press of the VIEW key, the display will go back to display the current temperature. To view a different input, select that input and repeat the procedure.

NOTES:

- MIN/MAX data can be viewed while recording is in progress (ie, REC annunciator(s) flashing). In this case, the VIEW function will display real-time running values of MIN or MAX temperatures.
- MIN/MAX data can be viewed after data recording is stopped. See STOP/CLR for instructions to stop recording. In this case, the VIEW function will display static data that does not update.
- The VIEW function cannot be initiated while the readout is in the SCAN mode. For example, to view the MAX value recorded for T2, first select mode T2, then depress the VIEW key.
- After selecting parameters to view, it is possible to go to the SCAN mode, and continue to view these parameters.

Example:

While in mode T1, view MAX. Then select mode T2, and view MIN. When SCAN is activated, the readout will sequentially display T1 (MAX), T2(MIN), T1-T2. This is a very powerful tool for analytical temperature analysis.

- If VIEW is enabled in a mode (T1, T2, or T1-T2) that was not recorded, the MAX and MIN annunciators will turn on as before. However, the numeric readout will indicate the current temperature. (Without RECORD being activated, the current reading, the maximum and the minimum readings are equivalent.)

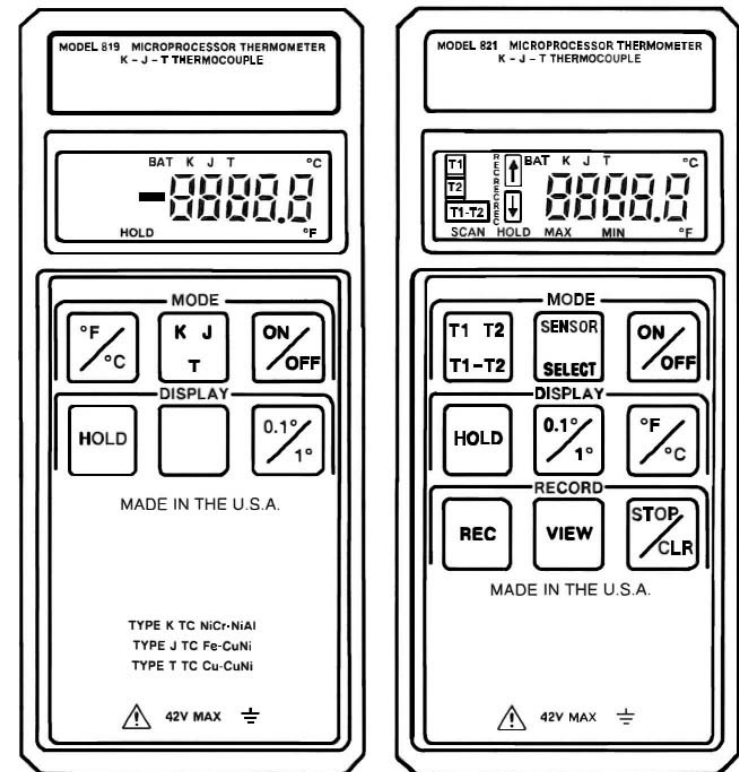

Figure 2. Display-Keypad Formats for Models 819/821

MEMORY BACKUP

During battery replacement, the contents of user-programmed memory (data, operating modes, etc.) can be saved. Prior to removing the old battery, turn off the instrument, and connect a Model 80010 battery charger. Then exchange batteries, and disconnect the battery charger. Do not leave the battery charger connected to instruments with non-rechargeable batteries.

OPERATION WITH RECHARGEABLE BATTERY

Model 80010 provides a 9-volt Ni-Cd battery and recharger suitable for use with the unit. This battery provides 15 hours of continuous operation. This duration can be extended indefinitely by operating simultaneously from both the battery and recharger.

OPERATING INSTRUCTIONS

The following instructions make reference to keypad inputs, and display readouts. Refer to Figure 2 to locate key switches, and identify display differences between thermometer models. Model 820 is similar in layout to the 821, except operation is limited to K and J thermocouples.

1. DIAGNOSTICS

Automatic diagnostics provide error indicators which are described below.

PROBLEM:

LIKELY CAUSE:

Blank display, unit does not power-up.

- (1) Improper battery installation. Check battery polarity.
- (2) Dead battery.

Low BAT Annunciator.

- (1) Low battery voltage, install a new battery. If problem persists, consult factory.

NOTE: The thermometer will display "OPEN" on any selected channel that does not have a thermocouple plugged in or if the thermocouple is open-circuited.

CAUTION

When using both thermocouple inputs, and a voltage differential exists between the two measurement points, at least one probe should be electrically insulated.

NOTES:

- T1 and T2 are not measured simultaneously. Therefore T1 and T2 readings can differ even when the temperatures are equal, if T1 and T2 are changing rapidly.
- Key selection is retained during power off.

REC

With the **REC** key, the recording of MIN/MAX temperatures is enabled. This function can be activated in one or more of the 3 measurement modes, T1, T2, and T1-T2. To start recording, select a desired measurement mode (T1, T2, or T1-T2), then press REC.

When more than one measurement mode is to be recorded, select the desired mode and then activate the record function. When REC is activated, a corresponding annunciator(s) will turn on and start flashing adjacent to the mode annunciator(s) (T1, T2, T1-T2). The flashing REC annunciator means that minimum and maximum data is being recorded. The instrument has 3 separate acquisition files which allow simultaneous recording of all three modes.

NOTE: REC cannot be started while the readout is in the SCAN mode. However, after recording is initiated, the readout can be set to the SCAN mode.

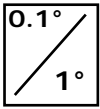

The **DISPLAY RESOLUTION** key selects whether the temperature readings will be displayed in high resolution (0.1°C or °F) or low resolution (1°C or °F). At initial power-up, the thermometer will read in high resolution.

NOTE:

- Key selection is retained during power off.

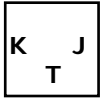

(or)

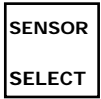

The **THERMOCOUPLE TYPE SELECTION** key selects which type of thermocouple the thermometer will be set up to use (Type K, J or T). Upon initial power-up, the thermometer will be ready to accept a K Type thermocouple. To change the thermometer to accept a Type J thermocouple, press the THERMOCOUPLE TYPE SELECTION key. Press the key a second time to select Type T. To change back, press the key until desired type is displayed. Thermocouple probe plugs are color coded. Type K Thermocouples have a yellow plug, Type J Thermocouples have a black plug, and Type T Thermocouples have a blue plug.

NOTES:

- Key selection is retained during power off.
- To insure proper temperature readings, be sure that the displayed thermocouple type matches the type of thermocouple you are using.



The **HOLD** key, when pressed, will “freeze” the temperature readings on the display. To get out of the Hold mode, press the HOLD key a second time.

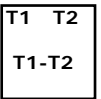

The **INPUT SELECTION/SCAN** key selects which thermocouple input the thermometer will display; thermocouple T1, thermocouple T2 or the difference between thermocouples T1 and T2. Upon initial power-up, the thermometer will default to channel T1. To select channel T2, press the INPUT SELECTION key (input selection annunciator **T2** will appear). To view the difference between the two inputs, calculated as T1 minus T2, press the INPUT SELECTION key a second time (input selection annunciator **T1-T2** will appear).

To scan inputs T1, T2, T1-T2, press the INPUT SELECTION/SCAN key a third time. (The SCAN annunciator will then appear.) The unit will then sequentially display the readings of T1, T2 and T1-T2. To return to T1, press the key again.

Display reads **OPEN**

(1) No thermocouple or a damaged thermocouple is plugged into the selected input.

NOTE: When viewing T1-T2, there must be a thermocouple plugged into both input jacks.

Display reads **E1** momentarily.

(1) This indicates that an invalid entry has been made. Review keystroke sequence, or consult manual for input instructions.

Display reads **E2** during temperature measurement.

(1) This indicates the temperature range has been exceeded for this thermocouple type. Remove thermocouple from temperature source.

WARNING

Do not touch the probe sheath when measuring excessively high or low temperatures.

WARNING

Probe damage and personal injury could result from exceeding a probe's maximum temperature ratings.

2. DISPLAY ANNUNCIATORS

Each item on the display (Figure 2) is described below in detail. To better familiarize yourself with the thermometer's display annunciators, please read this section.

1. **T1 T2 T1-T2** Input Selection Annunciator

This annunciator will indicate which input is being monitored.

- T1** — thermocouple T1
- T2** — thermocouple T2
- T1-T2** — the difference between the two thermocouples T1-T2

2. **Record Annunciator**

A flashing record symbol adjacent to a corresponding input selection annunciator indicates that this channel is being recorded. A static record symbol indicates data has been recorded, but is not being updated.



3. **Trend Indication Annunciators**

When the up-arrow is displayed, the reading is increasing.
When the down-arrow is displayed, the reading is decreasing.
When both arrows are displayed, the reading is stable.
When the second arrow is flashing on and off — the sensor is approaching a stable reading.

4. **BAT Low Battery Annunciator**

This symbol appears when less than 10% of battery life remains.

5. **K J T Thermocouple Type Annunciator**

These symbols indicate the thermocouple type selection.

NOTE: To insure correct temperature readings, the displayed thermocouple type must match the thermocouple used.

6. **Numeric Display**

The 5 digit numeric display indicates the temperature of the selected thermocouple, T1 or T2, or T1-T2.

7. **°C, °F Temperature Scale Annunciators**

The °C and °F symbols indicate whether the temperature readings are displayed in degrees Celsius or degrees Fahrenheit.

8. **MIN Minimum Annunciator**

This symbol appears when the display is showing the minimum reading stored while in the record mode.

9. **MAX Maximum Annunciator**

This symbol appears when the display is showing the maximum reading stored while in the record mode.

10. **HOLD Hold Annunciator**

This symbol will indicate that the instrument display is on hold.

11. **SCAN Scan Annunciator**

This annunciator will be displayed when the instrument is sequentially viewing T1, T2 and T1-T2.

3. **FUNCTION KEYS**



The **ON/OFF** key turns the thermometer on or off. To turn the thermometer on, press the ON/OFF Key once. All the display annunciators and segments should turn on momentarily (see Figure 2) for visual checking. During this period the thermometer performs internal diagnostics.

Following display test, if no input thermocouple is connected to the unit, the display will indicate "OPEN".

Plugging a thermocouple into the appropriate TC connector will give actual thermocouple temperature readings.

If the unit is turning on for the first time after installation of a new battery, it will default to K-type thermocouples, and °F readings with 0.1° resolution.

NOTE: To obtain full accuracy, allow 1-2 minutes after connecting a thermocouple plug, for thermal setting.

To turn the thermometer OFF, press the ON/OFF key a second time.



The **TEMPERATURE SCALE** key selects whether temperature readings will be displayed in degrees Fahrenheit or degrees Celsius. Upon initial power-up, the thermometer will display readings in degrees Fahrenheit. To display readings in degrees Celsius, press the TEMPERATURE SCALE key. To change back to degrees Fahrenheit, press the TEMPERATURE SCALE key a second time.

NOTE:

- Key selection is retained during power off.