

MODELS 1825 & 1827

Economical Power Sensor Calibrators

Service Manual

TEGAM INC.

**MODELS 1825 & 1827
ECONOMICAL POWER SENSOR CALIBRATORS**



MODEL 1825



MODEL 1827

Service Manual
PN# 1825-902-01CD
Publication Date: April 2007
REV. D

NOTE: This user's manual was as current as possible when this product was manufactured. However, products are constantly being updated and improved. Because of this, some differences may occur between the description in this manual and the product received.

TEGAM is a manufacturer of electronic test and measurement equipment for metrology, calibration, and production test. We also provide repair, calibration, and other support services for a wide variety of test and measurement equipment including RF power sensor calibration systems, RF attenuation measurement systems, resistance standards, ratio transformers, arbitrary waveform generators, micro-ohmmeters, LCR meters, handheld temperature calibrators, thermometers, humidity and temperature control devices, and more.

TEGAM also repairs and calibrates test and measurement equipment formerly manufactured by Electro-Scientific Industries (ESI), Gertsch, Keithley Instruments, Lucas Weinschel, and Pragmatic Instruments. A complete list can be viewed on our Product Service Directory at www.tegam.com

For more information about TEGAM and our products, please visit our website at www.tegam.com; or contact one of our customer service representatives at sales@tegam.com or 800-666-1010.



Ten Tegam Way,
Geneva, Ohio 44041

Telephone: (440) 466-6100
Fax: (440) 466-6110
E-mail: sales@tegam.com

I	THEORY OF OPERATION	1-1
	Specifications	1-2
	Table 1.1 Physical and Electrical Specifications for the Models 1825 and 1827	1-2
	1825 and 1827 Front Panel Description	1-3
	Figure 1.1 Model 1825 and 1827 Front Panel	1-3
	1825 and 1827 Rear Panel Description	1-4
	Figure 1.2 Model 1825 and 1827 Rear Panel	1-4
	Principal of DC Substitution	1-5
	Precision Power Measurement	1-5
	Self-Balancing Bridge Circuits.....	1-5
	Figure 1.3 Simplified Schematic of the 1825/1827 Bridge Circuit	1-6
	Power Measurements.....	1-6
	Controlling Thermistor Temperature.....	1-7
	Figure 1.4 Simplified Schematic of the 1825/1827 Heater Circuit	1-8
	Calculating Uncertainty	1-8
	Power Standard Calibration Uncertainty.....	1-9
	Mismatch Uncertainty (M_{ER})	1-9
	Gamma Correction	1-9
	Instrumentation Uncertainty (I_E)	1-10
	Table 1.2 Typical Instrumentation Error Analysis (I_E)	1-10
II	PREPARATION FOR SERVICE	2-1
	Safety Information & Precautions	2-2
	Terms in this Manual	2-2
	Terms as Marked on Equipment.....	2-2
	Symbols.....	2-2
	Grounding the Equipment.....	2-3
	Danger Arising from the Loss of Ground	2-3
	Use in Proper Environment	2-3
	Do Not Use in Explosive Environments.....	2-3
	Do Not Block Air Vents on Rear Panel	2-3
	Figure 2.1 Model 1825 and 1827 AC INPUT POWER and FUSE Location	2-3
	Servicing Safety Summary	2-4
	Do not Service Alone	2-4
	Use Care when Servicing with Power On or Off	2-4
	Power Source	2-4
	Line Voltage Selection.....	2-4
	Check the Power Cord.....	2-4
	Use the Proper Fuse.....	2-5
	Figure 2.2 Location of the FUSE.....	2-5
III	Function Tests.....	3-1
	Table 3.1 List of Equipment Required for Functional Tests	3-2
	Figure 3.1 Top view layout of Model 1825/1827 subassemblies	3-2
	Visual Inspection.....	3-3
	Figure 3.2 Location of four rear panel screws.....	3-3
	Figure 3.3 Rear panel tilted down	3-3
	Float/Ground Switch	3-4

Power-Up Operational Test	3-4
Heater Circuit Functionality Test	3-5
Power Supply Tests	3-5
Bridge Noise Test	3-6
IV CALIBRATION	4-1
Table 4.1 List of Equipment Required for Calibration.....	4-2
Figure 4.1 Top view layout of Model 1825/1827 subassemblies	4-3
Remove the Top Cover	4-4
Figure 4.2 Location of four rear panel screws.....	4-4
Figure 4.3 Rear panel tilted down	4-4
Bridge Board Circuitry Test and Calibration	4-5
Calibration of Internal Resistance	4-5
Figure 4.4 Location of shorting links and Red, Black, Blue, and White Binding Posts.....	4-6
Power Splitter Calibration	4-7
Figure 4.5 Four screws that secure the thermistor mount assembly	4-7
Figure 4.6 Location of two screws used to clamp the power splitter	4-8
Thermistor Bias Voltage Calibration.....	4-9
Calibration Factor	4-10
VI SERVICE INFORMATION	5-1
Warranty	5-2
Warranty Limitations	5-2
Statement of Calibration	5-2
Contact Information	5-2
Preparation for Calibration or Repair Service	5-3
Expedite Repair & Calibration Form	5-4

THEORY OF OPERATION
PREPARATION FOR SERVICE
FUNCTION TESTS
CALIBRATION
SERVICE INFORMATION

Specifications

Table 1.1 Physical and Electrical Specifications for the Models 1825 and 1827

Model	1825	1827
Frequency Range	10 MHz to 18 GHz	100 kHz to 18 GHz
Power Range	0.01 to 25 mW (-20 to +14 dBm)	0.01 to 25 mW (-20 to +14 dBm)
DC Substitution Bridge Accuracy	±0.003%	±0.003%
RF Impedance	50 Ohms nominal	50 Ohms nominal
SWR (SENSOR)	≤ 1.14	≤ 1.14
Power Linearity	<0.1% from 1 to 10 mW	<0.1% from 1 to 10 mW
Insertion Loss (RF IN)	6 dB nominal, 9.5 dB max	6 dB nominal, 10 dB max
Individual calibrations traceable to NIST supplied at the following frequencies:	10 to 100 MHz in 10 MHz steps 0.1 to 2 GHz in 50 MHz steps 2 to 4 GHz in 100 MHz steps 4 to 12.4 GHz in 200 MHz steps 12.75 to 18 GHz in 250 MHz steps	100, 200, 455 kHz 1, 1.25, 3, 5 MHz 10 to 100 MHz in 10 MHz steps 0.1 to 2 GHz in 50 MHz steps 2 to 4 GHz in 100 MHz steps 4 to 12.4 GHz in 200 MHz steps 12.75 to 18 GHz in 250 MHz steps
Calibration Factor Accuracy	+/-1.00% from 0.01 to 10 GHz +/-1.10% from 10 to 18 GHz	+/-0.80% from 0.1 to 10 MHz +/-1.00% from 0.01 to 10 GHz +/-1.10% from 10 to 18 GHz
Connectors SENSOR RF IN VOLTMETER	N-type Female SMA Female Binding Post, standard 0.75" spacing for banana plugs	N-type Female SMA Female (X2) Binding Post, standard 0.75" spacing for banana plugs
Temperature Operating Storage	+12° to +32° C (+54° to +90° F) -40° to +75° C (-40° to +167° F)	+12° to +32° C (+54° to +90° F) -40° to +75° C (-40° to +167° F)
Warm up time	2 hours minimum from instrument power up	2 hours minimum from instrument power up
Power Requirements	100VA, 50 to 400 Hz, 105 to 125 Vac standard or 210 to 250 Vac with a factory installed option.	100VA, 50 to 400 Hz, 105 to 125 Vac standard or 210 to 250 Vac with a factory installed option.
Input Power Fuse	Slo-Blo, 0.8 Amp for 110 Vac or 0.5 Amp for 220 Vac	Slo-Blo, 0.8 Amp for 110 Vac or 0.5 Amp for 220 Vac
Weight	16.2 lbs (7.3 kg)	17.7 lbs (8.03 kg)
Physical Dimensions Height Width Depth	3.5 in (88.9 mm) 18 in (457.2 mm) 15.4 in (391.2 mm)	3.5 in (88.9 mm) 18 in (457.2 mm) 15.4 in (391.2 mm)
Rack Mounting	Can be mounted in a standard 19" rack with rack mount kit RM-1825.	Can be mounted in a standard 19" rack with rack mount kit RM-1825.

Model 1825 and 1827 Front Panel Description

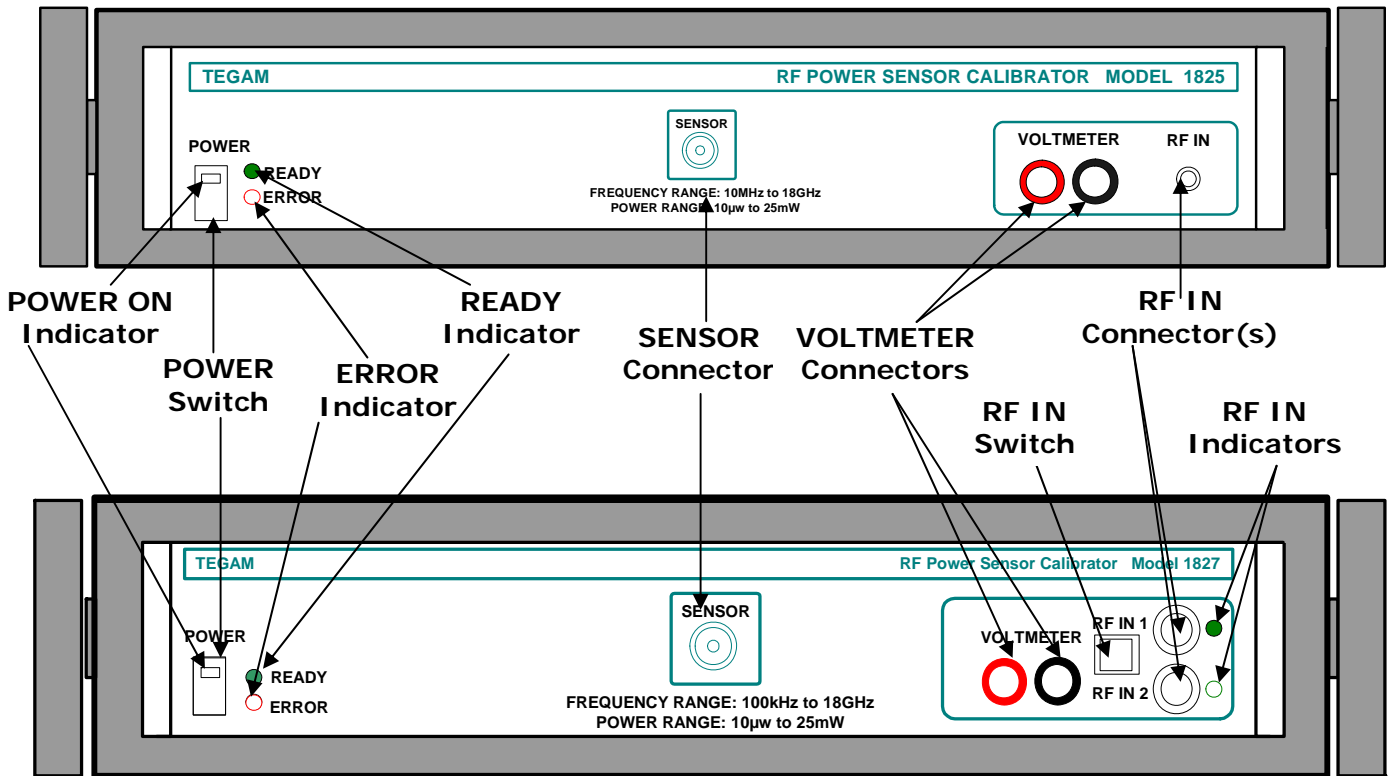

Figure 1.1 Model 1825(top) and 1827(bottom) Front Panel

POWER Switch (Both Models)

The POWER switch switches the power input to the instrument on and off. This switch has a built-in indicator that is illuminated when power is on. See POWER ON indicator.

POWER ON Indicator (Both Models)

The POWER ON indicator illuminates when instrument power is on. It is built into the POWER switch.

READY Indicator (Both Models)

The READY indicator is a green LED that illuminates when the RF power standard has reached its internal operating temperature of 60°C. Allow two hours for the power standard to reach this temperature and ensure the READY indicator stays illuminated during RF power sensor calibrations.

ERROR Indicator (Both Models)

The ERROR indicator is a red LED that illuminates for any condition preventing the Type IV Bridge circuit from balancing. When the ERROR indicator becomes illuminated, stop any calibration and contact TEGAM for assistance.

SENSOR Connector (Both Models)

The SENSOR connector is an N-type female connector for the Sensor Under Tests (SUT). This connector provides the RF power to the SUT. The RF power applied to RF IN connector is applied equally to the SUT and the internal power standard. The fact that equal RF power is applied to both the power standard and the SUT is what allows the calibration factor of the SUT to be determined.

VOLTMETER Connectors (Both Models)

The VOLTMETER Connectors are spade-lug connecting posts/banana jacks. These connectors complete the DC path between the Model 1825 and a digital voltmeter with at least 6½-digit resolution. DC voltage present across the VOLTMETER connectors is equivalent to the voltage across the thermistor element. The red connector is for positive (+) DC voltage and the black connector is for negative (-) DC voltage.

RF IN Connector (Model 1825)

The RF IN connector is an SMA female connector that connects to the signal generator output. The RF power that comes in this connector is applied equally to the SUT and the power standard. The fact that equal RF power is applied to both the power standard and the SUT is what allows the determination of the SUT calibration factor. There is about 6 to 9.5 dB of insertion loss in the RF IN path.

RF IN 1 and RF IN 2 Connectors (Model 1827)

The RF IN 1 and 2 are both SMA female connectors that connect to signal generator outputs. Two inputs are provided because it is often necessary to use two different signal generators to cover the 100 KHz to 18 GHz frequency range of the Model 1827. The RF power that comes in this connector is applied equally to the SUT and the power standard. The fact that equal RF power is applied to both the power standard and the SUT is what allows the determination of the SUT calibration factor. There is about 6 to 10 dB of insertion loss in the RF IN path.

RF IN 1/RF IN 2 Switch (Model 1827)

The RF IN 1 / RF IN 2 switch is a toggle switch that is used to select which RF Input is active. The switch position indicates which input is active. When the switch is up RF IN 1 is active, when the switch is down RF IN 2 is active. This switch allows RF sources to be changed without disconnecting and reconnecting cables.

RF IN 1 and RF IN 2 Indicators (Model 1827)

The RF IN 1 and RF IN 2 indicators are green LEDs that illuminate when the RF input next to it is active.

Model 1825 and 1827 Rear Panel Description

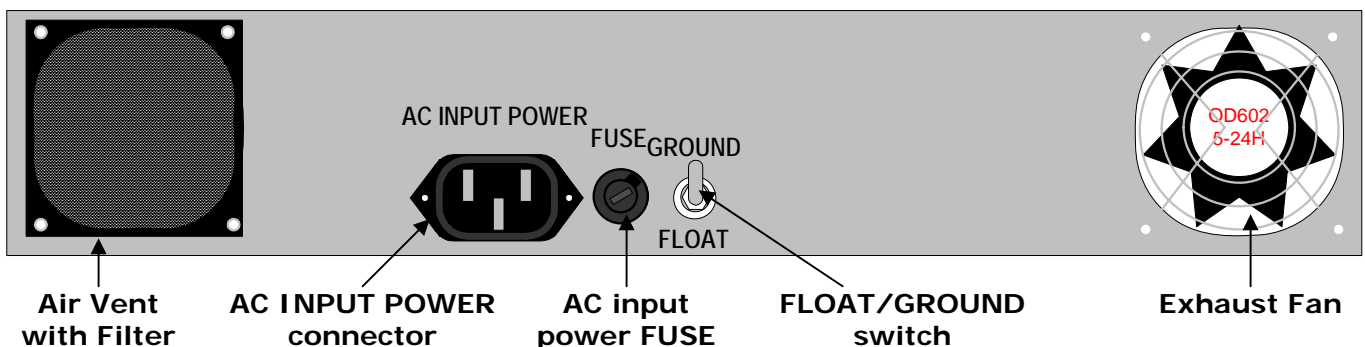

Figure 1.2 Model 1825 and 1827 Rear Panel

Air Vent with Filter

The Air Vent allows air to flow into the Model 1825/1827 to keep the internal components from overheating. The filter keeps debris from entering the instrument. Ensure there is at least two inches of space behind the instrument for proper airflow.

AC INPUT POWER connector

The AC INPUT POWER connector is a three prong connector mates with AC power cord supplied with the unit.

AC input power FUSE

The AC input power FUSE protects the instrument from an over-current condition. A 0.8 Amp slo-blo fuse is used with the standard 110 Vac power supply, a 0.5 Amp slo-blo is used with the optional 220 Vac power supply.

FLOAT/GROUND Switch

The FLOAT/GROUND Switch is a two position toggle switch located on the rear panel. This switch connects and disconnects the bridge board ground to chassis ground; the up position connects the bridge board to ground and the down position disconnects the bridge board from ground (floats). Normal operation is with the switch in the GROUND (up) position. If the LO (-) input of the external DVM is grounded, then the switch should be in the FLOAT (down) position.

Exhaust Fan

The Exhaust Fan causes air to flow out of the Model 1825/1827 to keep the internal components from overheating. Ensure there is at least two inches of space behind the instrument for proper airflow.

Principle Of DC Substitution

The Model 1825 and 1827 use the principle of DC substitution to measure RF power. DC substitution refers to the measurement of RF power according to the amount of DC power that must be substituted for the RF power in a bolometer in order to cause equivalent thermal effects. Since some of the RF power applied to the input of the power standard is lost by reflection and other causes before it is applied to the thermistor element, the calibration factor of the standard is applied by the following formula to determine the actual level of RF power:

$$P_{RF} = \frac{P_{dc}}{K_2}$$

Where:

P_{RF} = Level of applied RF power,

P_{dc} = DC substituted power which is proportional to the applied RF power,

K_2 = calibration factor of Model 1825/1827 traceable to NIST

Precision Power Measurement

The Model 1825 and 1827 RF Power Sensor Calibrators and a digital voltmeter with at least a 6½-digit resolution combine to provide the precision power measurement system. This system features the Model 1825/1827 closed-loop, self-balancing Type IV Bridge circuit consisting of two legs - a precision resistance leg 200 ohms and a leg linked to a thermistor element in the Model 1825/1827 power standard. A thermistor is a type of bolometer whose resistance decreases as a function of increasing heat associated with ambient temperature or applied power.

This system also features the Model 1825/1827 temperature control circuitry that temperature stabilizes the thermistor element. This eliminates changes in the thermistor element's resistance due to ambient temperature changes and thus isolates the causes of thermistor variation to the application of RF and DC power only.

Self-Balancing Bridge Circuits

The Model 1825 and 1827 contain a bridge circuit that performs DC substitution. Figure 1.3 shows a simplified schematic of the bridge circuit in the Model 1825 and 1827.

The self-balancing bridge circuit, in a closed-loop configuration, consists of two legs: a precision resistance leg 200-ohm and a leg containing a thermistor element. The precision resistance leg maintains a constant effective resistance value of 200 ohms. When the power standard is

temperature stabilized by the temperature control circuit, thermistor resistance varies solely due to the application of RF and DC power.

Each leg uses an operational amplifier (U1 or U2) to sense voltage imbalances and to drive transistors (Q1 and Q2) to correct them. The power supply assembly provides isolated ±15 volt biasing to each op-amp. Since the voltage differential at the input stage of op amp U2 is negligibly small, it provides a virtual common reference to op amp U1 (i.e., it acts as a virtual common ground since the voltage approaches zero with respect to either ground). This forces the current through the thermistor to equal the current through the precision resistance leg.

The application of RF power to the thermistor element creates a decrease in the voltage drop across the thermistor element due to its negative temperature coefficient. This decreased voltage drop, in turn, creates an unbalanced bridge condition. When resistance in the thermistor element leg of the bridge changes due to the application of RF power, op amp U1 senses a voltage difference between V_a and V_a' and causes V_a' to equal V_a . When V_a' equals V_a , the voltage across the thermistor element leg equals the voltage across the precision resistance leg. Also, the closed loop circuit configuration maintains equal current throughout the bridge. Since the voltage and current throughout the circuit is equal, the resistance in both halves is also equal. Therefore, when the thermistor mount's temperature is stabilized and RF power is applied, a change in voltage across the precision resistance leg is proportional to the amount of RF power applied to the thermistor element.

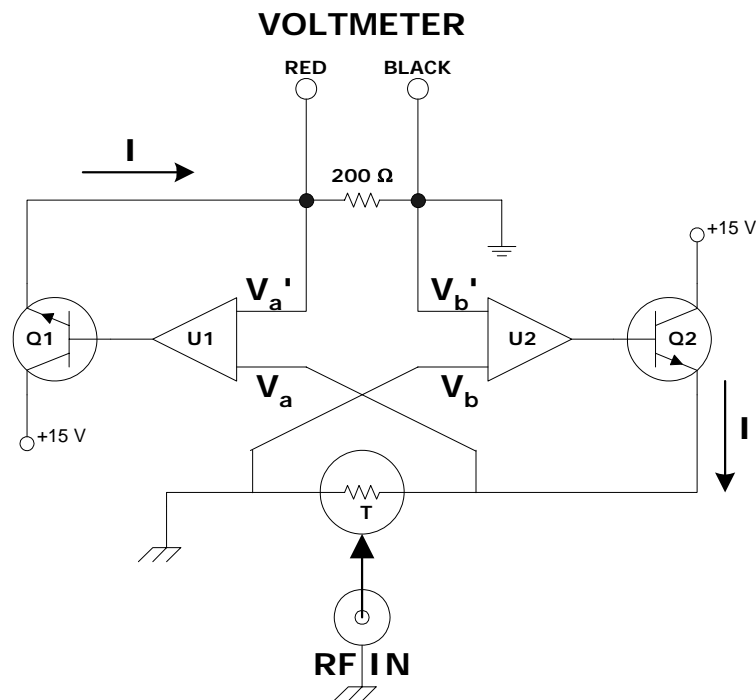

Figure 1.3 Simplified Schematic of the Model 1825/1827 Bridge Circuit

Power Measurements

The precision measurement system measures RF power in terms of a power change across the precision resistance leg. A digital voltmeter measures voltage across the precision resistance leg which can be used to determine the power by the following equation:

$$P = \frac{V^2}{200}$$

Where:

P = power across the precision resistance leg

V = voltage measured across the precision resistance leg
 200 = resistance value of precision resistance leg

The RF power introduced to the thermistor is directly proportional to the change in DC power across the precision resistor. The change in DC power across the precision resistor leg is given by:

$$\Delta P = P_1 - P_2$$

Where:

- ΔP = the change in power across the precision resistance leg when RF power is applied to the thermistor leg,
- P_1 = power across the precision resistance leg without RF power applied,
- P_2 = power across the precision resistance leg with RF power applied

To determine the power across the precision resistance leg without RF power applied, measure the voltage before the application of RF power (V_1). To determine the power across the precision resistance leg with RF power applied, measure the voltage during the application of RF power (V_2). Once these two voltage measurements are made, the power can be determined by using the first equation. By substituting for P_1 and P_2 from the previous formula:

$$\Delta P = \frac{(V_1)^2}{200} - \frac{(V_2)^2}{200}$$

Combining terms:

$$\Delta P = \frac{(V_1)^2 - (V_2)^2}{200}$$

Where:

- ΔP = the change in power across the precision resistance leg when RF power is applied to the thermistor leg,
- V_1 = DVM reading across the bridge in the absence of RF power,
- V_2 = DVM reading across the bridge with RF power applied,
- 200 = nominal resistance of the 1825/1827 thermistor in Ohms,

Since the change in power across the precision resistor is DC power, ΔP is also represented as P_{dc} . The change in DC power across the precision resistor is directly proportional to the RF power introduced to the thermistor. Like all RF power sensors, some of the RF power applied to the input of the Model 1825/1827's power standard is lost by reflection and other causes before it is applied to the thermistor element. Thus, calibration factors based on frequency are associated with the Model 1825 and 1827 and are applied in the following formula to determine the actual level of RF power:

$$P_{RF} = \frac{P_{dc}}{K_2}$$

Where:

- P_{RF} = Level of applied RF power,
- P_{dc} = DC substituted power which is proportional to the applied RF power,
- K_2 = calibration factor of Model 1825 or 1827 traceable to NIST

Controlling Thermistor Temperature

The Model 1825 and 1827 contain a thermistor which is a temperature-sensitive device. In order to provide precise measurements, the effects of changes in the ambient temperature upon the thermistor must be eliminated or minimized. The Model 1825/1827 temperature controller accomplishes this by raising the power standard's internal temperature to a level higher than the ambient temperature (approximately 60° C) and maintaining that level by controlling the current applied to the power standard's heater element. This prevents any thermistor imbalance due to ambient temperature change. Therefore, all temperature changes are due to the application of RF and DC power.

U_C = uncertainty of the calibration for the RF Power Standard which is frequency dependent,
 I_E = the random part of the uncertainty of the instrumentation,
 M_{ER} = mismatch error which is frequency dependent.

Power Standard Calibration Uncertainty (U_C)

This value is provided as part of the calibration of the RF Power Standard. The Power Standard for calibrating sensors would be the Model 1825 or 1827. If the Model 1825/1827 is being calibrated, U_C would come with the correction data provided with the Primary RF Power Standard.

Mismatch Uncertainty (M_{ER})

Device mismatch is the term used to describe the differences in impedance between RF devices. This difference in impedance causes some of the RF power to be reflected back from one device to another; thus, not all applied RF power is transferred from one device to another. The amount of power that is not transferred can be characterized as the reflection coefficient, or Γ . The reflection coefficient for the Model 1825 and 1827 is included as part of the calibration data. Mismatch error (M_{ER}) is determined from the reflection coefficients of both the Model 1825 or 1827 and the SUT as follows:

$$M_{ER} = 1 - \frac{1}{(1 \pm |\Gamma_1| \times |\Gamma_2|)^2}$$

Where:

- M_{ER} = residual mismatch error,
- Γ_1 = reflection coefficient for the Model 1825/1827,
- Γ_2 = reflection coefficient for the SUT.

Reflection Coefficient is a complex number expressed as a vector quantity. A vector quantity has two components a magnitude and phase angle. The magnitude of the reflection coefficient is symbolized by the Greek letter rho ρ and the phase angle by the Greek letter phi ϕ . Often, the magnitude is the only part of the reflection coefficient used, which will yield a "worse case" mismatch uncertainty. Sometimes the Standing Wave Ratio (SWR) of a device is given rather than the reflection coefficient (Γ). SWR is a scalar quantity and relates to ρ as follows:

$$\rho = \frac{S - 1}{S + 1}$$

Where:

- ρ = magnitude of the reflection coefficient,
- S = Standing Wave Ratio (SWR).

Impedance mismatch between all devices connected to the SENSOR port of the 1825/1827 should be included in M_{ER} . That means the reflection coefficient or VSWR of any adapter, attenuator, or matching pad used should be known. To include these devices, use the equations above to determine the mismatch uncertainty between each device that is connected together. M_{ER} is the sum of those mismatch uncertainties.

Gamma Correction

If both the ρ and ϕ of the reflection coefficient are known for both the SUT and 1825/1827 (TEGAM provides this data as part of the calibration for the 1825/1827), then Gamma corrections can be applied to the calibration factor of the SUT. Applying Gamma corrections to the calibration factor reduces the total uncertainty of the calibration by virtually eliminating M_{ER} . Gamma corrections are applied to the SUT's cal factor as follows:

$$\text{Corrected } K_{1S} = \frac{K_{1S}}{|1 + \Gamma_1\Gamma_2|^2}$$

Where:

- Corrected K_{1S} = cal factor of the SUT after Gamma correction are applied,
- K_{1S} = cal factor of the SUT before Gamma correction is applied,

Γ_1 = reflection coefficient of the 1825 or 1827,
 Γ_2 = reflection coefficient of the SUT

That equation can be “simplified” to :

$$\text{Corrected } K_{1S} = \frac{K_{1S}}{(1 - \rho_1\rho_2 \cos(\phi_1 + \phi_2))^2 + (\rho_1\rho_2 \sin(\phi_1 + \phi_2))^2}$$

Instrumentation Uncertainty (I_E)

These uncertainties are limited by the quoted accuracies of the various equipment involved. Refer to Table 1.2 for an analysis.

Table 1.2 A Typical Instrumentation Error Analysis (I_E)

Item	Specified Accuracy	Effect on Uncertainty
Model 1825/1827		
DC Substitution Bridge Accuracy	±0.003%	±0.003
Connector Repeatability	±0.1%	±0.1
Temperature drift	±0.05%	±0.05
Power Linearity (1 to 10 mW)	±0.1%	0 at 1mW
Total RSS Uncertainty		±0.51%
Other Instruments		
Digital Voltmeter Accuracy	See manufacturer’s specifications	
Digital Voltmeter Nonlinearity	See manufacturer’s specifications	
Power Meter Accuracy	See manufacturer’s specifications	

It should be noted that the Model 1825 and 1827 are calibrated at 1 mW. If the transfer to the SUT is also performed at 1 mW, then the Power Linearity has zero effect. Otherwise, to determine Power Linearity, multiply the nominal power level by ±0.01% up to a nominal power level of 10 mW. From 10 to 25 mW, the additional Power Linearity becomes negligible.

THEORY OF OPERATION
PREPARATION FOR SERVICE
FUNCTION TESTS
CALIBRATION
SERVICE INFORMATION

Safety Information & Precautions:

The following safety information applies to both operation and service personnel. Safety precautions and warnings may be found throughout this instruction manual and the equipment. These warnings may be in the form of a symbol or a written statement. Below is a summary of these precautions.

Terms in This Manual:

CAUTION statements identify conditions or practices that could result in damage to the equipment or other property.

WARNING statements identify conditions or practices that could result in personal injury or loss of life.

Terms as Marked on Equipment:

CAUTION indicates a personal injury hazard not immediately accessible as one reads the marking, or a hazard to property including the equipment itself.







DANGER indicates a personal injury hazard immediately accessible as one reads the marking.

Symbols:

As Marked in This Manual:

	This symbol denotes where precautionary information may be found.
---	---

As Marked on Equipment:

	CAUTION – Risk of Danger
	DANGER – Risk of Electric Shock
	Earth Ground Terminal
	On
O	Off
	Frame or Chassis Terminal
	Earth Ground Terminal
	Alternating Current

Grounding the Equipment

This product is grounded through the grounding conductor of the power cord.

WARNING: To avoid electrical shock or other potential safety hazards, plug the power cord into a properly wired receptacle before using this instrument. The proper grounding of this instrument is essential for safety and optimizing instrument operation.

Danger Arising from Loss of Ground

WARNING: If the connection to ground is lost or compromised, a floating potential could develop in the instrument. Under these conditions all accessible parts, including insulating parts such as keypads and buttons could develop a hazardous voltage and put the user at risk.



Use in Proper Environment

Normal calibration laboratory practice dictates that the environment should be closely controlled. This will minimize errors introduced by temperature and humidity changes. A nominal temperature of +23°C (+73.4°F) provides a good working condition. A tolerance of ±1°C gives allowable temperature spread. Controlled temperatures also stabilize the aging process of the standards.

CAUTION: The Model 1825 and 1827 have a specified ambient temperature range of +12° to +32°C (+54° to +90°F). Operating beyond these limits can affect the accuracy of the instruments and damage internal circuitry.

CAUTION: When the Model 1825 or 1827 is to be stored for extended periods, pack the instrument into a container. Place container in a clean, dry, temperature-controlled location. If instrument is to be stored in excess of 90 days, place desiccant with items before sealing container. The safe environmental limits for storage are -40° to +75°C (-40° to +167°F) at less than 95% non-condensing relative humidity.

Do Not Use in Explosive Environments

CAUTION: The 1825/1827 is not designed for operation in explosive environments.

Do Not Block Air Vents on Rear Panel

CAUTION: The Model 1825 and 1827 have an air intake and exhaust on the back panel of the instrument. When installing the Model 1825/1827, ensure there is at least two inches of space behind the instrument for airflow. DO NOT set the instrument on its rear panel as its airflow will be restricted and may result in damage to the internal circuitry.

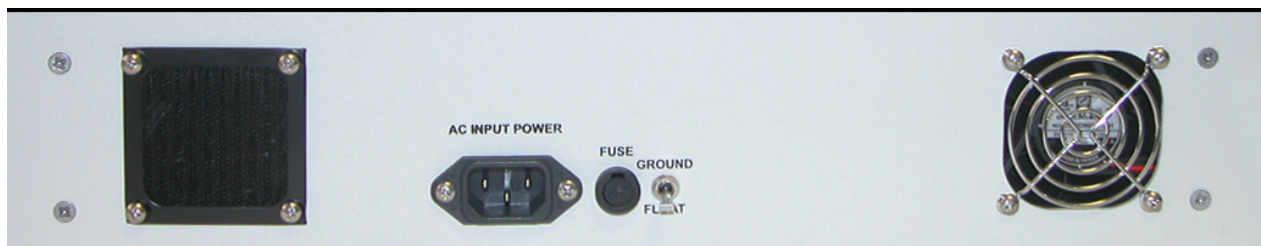

Figure 2.1 Model 1825 and 1827 AC INPUT POWER and FUSE location

FOR QUALIFIED SERVICE PERSONNEL ONLY**Servicing Safety Summary:****Do Not Service Alone**

Do not perform service or adjustment on this product unless another person capable of rendering first aid is present.

Use Care When Servicing with Power On or Off

Dangerous voltages may exist at several points in this product. To avoid personal injury or damage to this equipment, avoid touching exposed connections or components while the power is on. Assure that the power is off by unplugging the instrument when removing panels, soldering, or replacing components.

WARNING: The instrument power source is electronically controlled meaning that there is power present throughout the instrument even when the instrument is in the OFF state.

WARNING: Do not wear jewelry (rings, bracelets, metal watches, neck chains) while working on exposed equipment.

WARNING: Be very cautious about using hand tools near exposed backplanes, bus bars, or power supply terminals. Use properly insulated tools. When making test connections to the power supply terminals and bus bars; use only insulated probe tips.

Power Source

This product is intended to connect to a power source that will not apply more than 250V RMS between the supply conductors or between either supply conductor and ground. A protective ground connection by way of the grounding conductor in the power cord is essential for safe operation.

**Line Voltage Selection:**

CAUTION: DO NOT APPLY POWER TO THE INSTRUMENT BEFORE READING THIS SECTION:

The standard power supply in a Model 1825 or 1827 operates with a line voltage of 105 to 125 Vac at 50 to 400 Hz. A 210 to 250 Vac power supply can be ordered as a factory installed option. Each power supply requires a different fuse. It is strongly recommended that the line voltage, frequency, and fuse type be verified for the type of power supply in the unit before powering it.

Check the Power Cord

Make sure the power cord supplied with the Model 1825 or 1827 is not frayed, broken, or cracked. A damaged power cord is a fire and electrical hazard. If the power cord is damaged, it should be replaced (P/N 068-21).

Use the Proper Fuse

To avoid fire hazard, use only the correct fuse type as specified for the AC power supply in the unit.

For the standard 105-125 Vac power supply use a 0.8 Amp Slo-Blo fuse.

For the optional 210-250 Vac power supply use a 0.5 Amp Slo-Blo fuse.

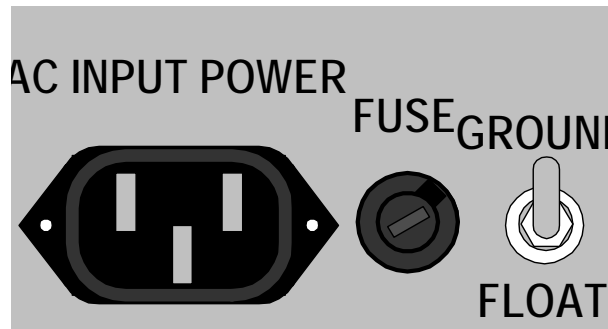

Figure 2.2 Location of the FUSE

The fuse is located between the AC INPUT POWER connector and the FLOAT/GROUND switch on the rear panel as depicted in Figure 2.2. Before replacing the fuse, place the Model 1825/1827 Front Panel Switch to the OFF position and remove power cord on the back of the Model 1825/1827. To replace the fuse, remove the fuse cap by inserting a flat screwdriver into the slot of the cap and rotate about $\frac{1}{4}$ counter-clockwise. The cap and fuse will spring out; replace the fuse. Align the tab on the fuse cap with the notch on the fuse housing, push the cap and fuse into the housing, and rotate the cap $\frac{1}{4}$ clockwise with a flat screwdriver to lock the cap down.

THEORY OF OPERATION
PREPARATION FOR SERVICE
FUNCTION TESTS
CALIBRATION
SERVICE INFORMATION

Table 3.1 List of Equipment Required for Functional Tests

Voltmeter (DC null detector) Range: Sensitivity of smallest scale: Input Impedance: Accuracy:	30 V 10%V 100 Kohm or greater (resistive) +/-2% of full scale
General purpose oscilloscope Bandwidth:	10 MHz
Ohmmeter Resolution	0.1 Ohms
9/64" Allen Wrench	
1N914 silicon diode or equivalent	

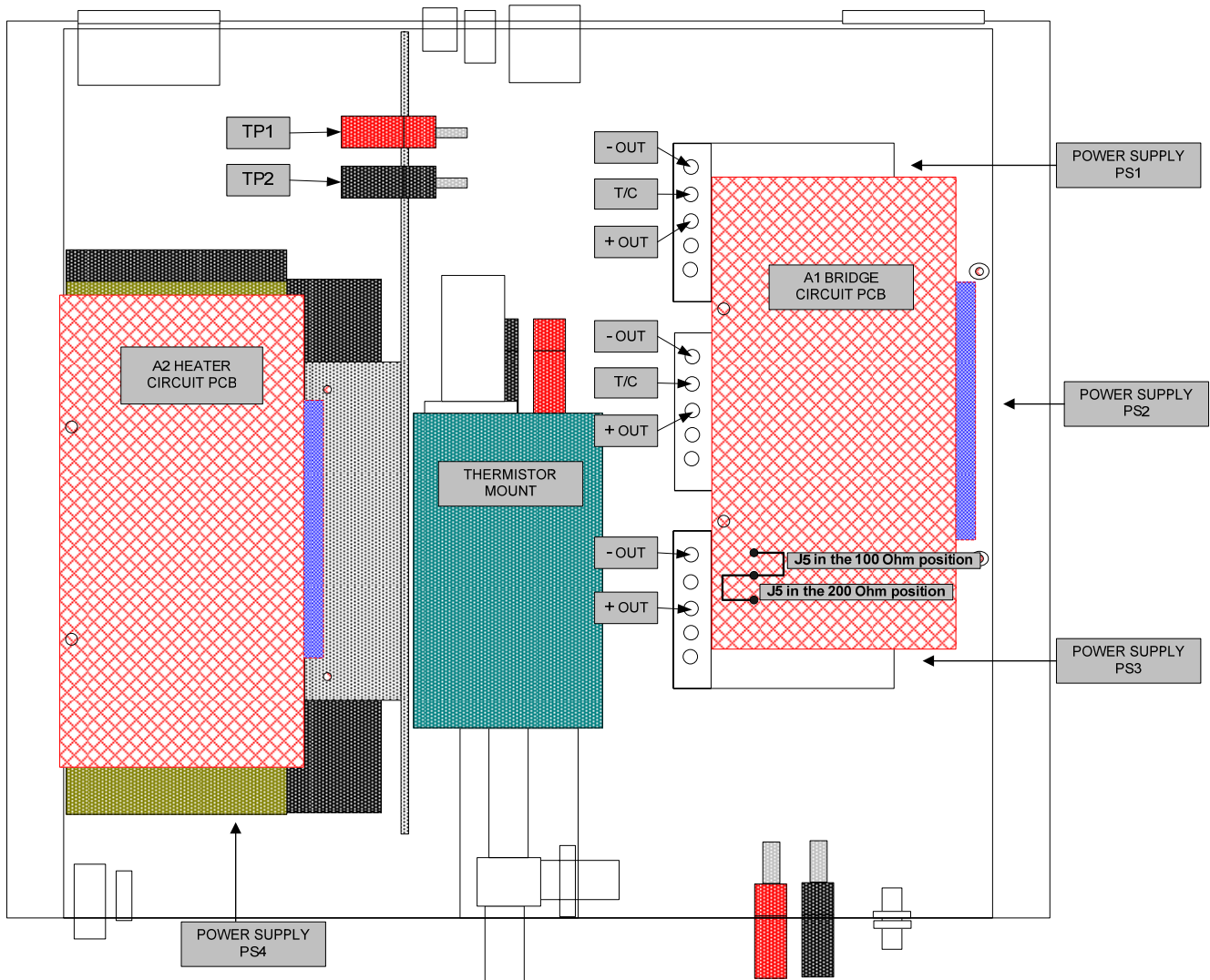

Figure 3.1 Top view layout of Model 1825/1827 subassemblies

Note: If any Function Test fails, contact TEGAM for assistance. Contact information and instructions for returning an instrument to TEGAM can be found in Chapter V Service Information in this manual.

Visual Inspection

Remove top cover of the Model 1825/1827 to expose the internal assemblies.

1. Remove four screws in rear panel using 9/64" Allen Wrench.



Figure 3.2 Location of four rear panel screws

2. Tilt rear panel down.
3. Slide top cover towards the rear of the unit.



Figure 3.3 Rear panel tilted down

4. Conduct a visual inspection of the Model 1825/1827 including the Power Supplies, Temperature Control Board, Bridge Circuit Board, Thermistor Mount, and Interconnections. Look for any obvious signs of damage.
5. Leave the top cover off to perform the rest of the Function Tests. Replace the cover and the rear panel when service on the Model 1825/1827 is finished.



Warning: Many of the procedures described are performed with power applied to the instrument while the protective covers are removed. The electrical energy present at some points may cause personal injury if directly contacted. These procedures should be performed by qualified personnel and caution should be used.

Float/Ground Switch Test

This procedure verifies proper operation of the Float/Ground switch located on the Rear Panel of the Model 1825/1827.

1. Ensure the Model 1825/1827 Front Panel Switch is in the OFF position.
2. Remove power cord on the back of the Model 1825/1827.
3. Switch the Float/Ground Switch to the Float position (refer to Figure 1.2).
4. Connect an Ohmmeter across PS1 T/C and the chassis. This measurement should indicate an open condition.
5. Place the Float/Ground Switch to the Ground position.
6. Repeat step 4, but now the Digital Volt Meter should indicate a short condition.
7. Place the Float/Ground Switch to the Float position.
8. Reconnect the power cord to the back of the Model 1825/1827.

Power-Up Operational Test

The power-up operational test ensures that the Model 1825/1827 power supplies and error indicator are working properly.

1. Ensure the Model 1825/1827 Front Panel Switch is in the OFF position.
2. Disconnect the thermistor mount bias cable by removing the spade lugs from the Red Binding Post (TP1) and the Black Binding Post (TP2).
3. Verify that fuse FS1 is installed and is the correct value.
4. Ensure the Model 1825/1827 rear panel FLOAT/GROUND Switch to the FLOAT position.
5. Turn the Model 1825/1827 POWER Switch to the ON position.
6. Ensure the POWER ON indicator ERROR LED illuminates.
7. Turn the Model 1825/1827 POWER Switch to the OFF position.

Heater Circuit Functionality Test

This procedure verifies the functionality of the thermistor mount heater, heater control circuit, and READY Indicator (DS1). The Model 1825/1827 should be off for at least 30 minutes. This will allow the thermistor standard to cool down enough to test the READY indicator.

1. Set the Model 1825/1827 front panel POWER Switch to the ON position and ensure that the front panel POWER ON Indicator lights.
2. Immediately verify that the READY LED is OFF.
3. Confirm that READY LED is illuminated within two hours. Illumination of the READY LED indicates a near thermal balanced condition of the thermistor mount heater. Approximately 2 hours are required to achieve mount temperature stability for a completely cold mount. During the time it takes for the thermistor heater to stabilize the Power Supply Verification test may be performed.
4. With power still applied, remove the thermistor mount heater cable. Verify that READY LED is extinguished.
5. Reconnect the heater cable, verify the READY LED is illuminated once again.

Power Supply Tests

This procedure verifies that the power supplies are operating properly and no internal or external component is causing a power supply overload condition. (Refer to Figure 3.1 for assembly location information).

1. Set the Model 1825/1827 front panel POWER Switch to the ON position and ensure that the front panel POWER ON Indicator illuminates.
2. Locate capacitor C1 on the Heater Circuit PCB (A2). Connect the positive lead of a Digital Voltmeter (DVM) to the lead of C1 marked "+" and the negative lead of the DVM to the other leg of C1. The voltage should be +20 VDC +/- 0.6 V.
3. Connect an oscilloscope probe to the lead of C1 marked "+" and the ground lead of the scope to the other leg of C1. Set the scope to measure the AC voltage. The ripple voltage should be less than 1 mVpp.
4. Using a DC Digital Voltmeter, measure between PS3 (+OUT) and (-OUT). Ensure that the positive lead of the DVM is connected to (+OUT) and the negative lead of the DVM is connected to (-OUT). The voltage should be +5 VDC +/- 0.1 V.
5. Using a DC Digital Voltmeter, measure between PS1 (+OUT) and (T/C). Ensure that the positive lead of the DVM is connected to (+OUT) and the negative lead of the DVM is connected to (T/C).
6. The voltage should be +15 VDC +/- 0.15 V.
7. Move the positive lead of the DVM to PS1 (-OUT), the voltage should be -15 VDC +/- 0.15 V.
8. Repeat Steps 5 through 7 for PS2.

9. Using an Oscilloscope, measure AC voltage between PS3 (+OUT) and (-OUT). Ensure that the scope probe is connected to (+OUT) and the ground lead of the scope probe is connected to (-OUT). The ripple voltage should be less than 3 mVpp.
10. Using an Oscilloscope, measure AC voltage between PS1 (+OUT) and (T/C). Ensure that the scope probe is connected to (+OUT) and the ground lead of the scope probe is connected to (T/C). The ripple voltage should be less than 3 mVpp.
11. Move the oscilloscope probe to PS1 (-OUT), the ripple voltage should be less than 3 mVpp.
12. Repeat Steps 10 and 11 for PS2.

Bridge Noise Test

The Bridge Noise Test employs an oscilloscope to measure noise on the Type IV bridge circuit. The bridge noise test ensures that the Model 1825/1827 Bridge does not source noise that would disrupt measurements or bridge balance capability.

1. Ensure the thermistor mount bias cable the spade lugs are disconnected from the Red Binding Post (TP1) and the Black Binding Post (TP2).
2. Connect the anode of the 1N914 diode to the Model 1825/1827 Red Binding Post (TP1).
3. Connect the cathode of the 1N914 diode to the to the Model 1825/1827 Black Binding Post (TP2).
4. Connect the oscilloscope's positive and negative terminals to the Model 1825/1827 VOLTMETER Red and Black Terminals (TP5 and TP6), respectively.
5. Set the Model 1825/1827 bridge board jumper, J5 to the 100 ohms position (refer to Figure 3.1).
6. Turn the Model 1825/1827 POWER Switch (S1) to the ON position.
7. Ensure that the oscilloscope indicates less than 10mV peak-to-peak amplitude with no short-term bursts or large peak transients.

THEORY OF OPERATION
PREPARATION FOR SERVICE
FUNCTION TESTS
CALIBRATION
SERVICE INFORMATION

Table 4.1 List of Equipment Required for Calibration

Voltmeter (X2) Range: Resolution: Input Impedance: Accuracy:	30 V 0.01 mV 100 Kohm or greater (resistive) +/-2% of full scale
General purpose oscilloscope Bandwidth:	10 MHz
TEGAM Model DB 877 Decade resistance box or equivalent Resolution:	0.1 Ohms
9/64", 7/64", and 5/64" Allen (Hex) Wrench	
1N914 silicon diode or equivalent	
TEGAM Model SR1-100 4-terminal resistance standard Nominal Value: Accuracy:	100 Ohms +/-0.01%
Scalar Network Analyzer Frequency Range:	100 kHz to 18 GHz; 1825 only requires 10 MHz to 18 GHz
Vector Network Analyzer (optional) Frequency Range:	100 kHz to 18 GHz; 1825 only requires 10 MHz to 18 GHz
TEGAM Model M1130 Primary RF Power Transfer Standard; a TEGAM Model M1110 can be used for the 1825 Frequency Range: Dynamic Range:	100 kHz to 18 GHz; 1825 only requires 10 MHz to 18 GHz 0 to 10 dBm (1 to 10 mW)
TEGAM Model 1806 Type IV Power Meter or equivalent Nominal Bridge Resistance: Bridge Accuracy:	200 Ohms +/-0.003%
CW RF Signal Source: Frequency Range: Power Output:	100 kHz to 18 GHz (two may be needed); 1825 only requires 10 MHz to 18 GHz 10 dBm, 6 dBm minimum
13/16" Torque Wrench Torque Value	13-15 in-lbs for N-type connectors
5/16" Torque Wrench Torque Value	7-8 in-lbs for SMA connectors
Philips screwdriver	

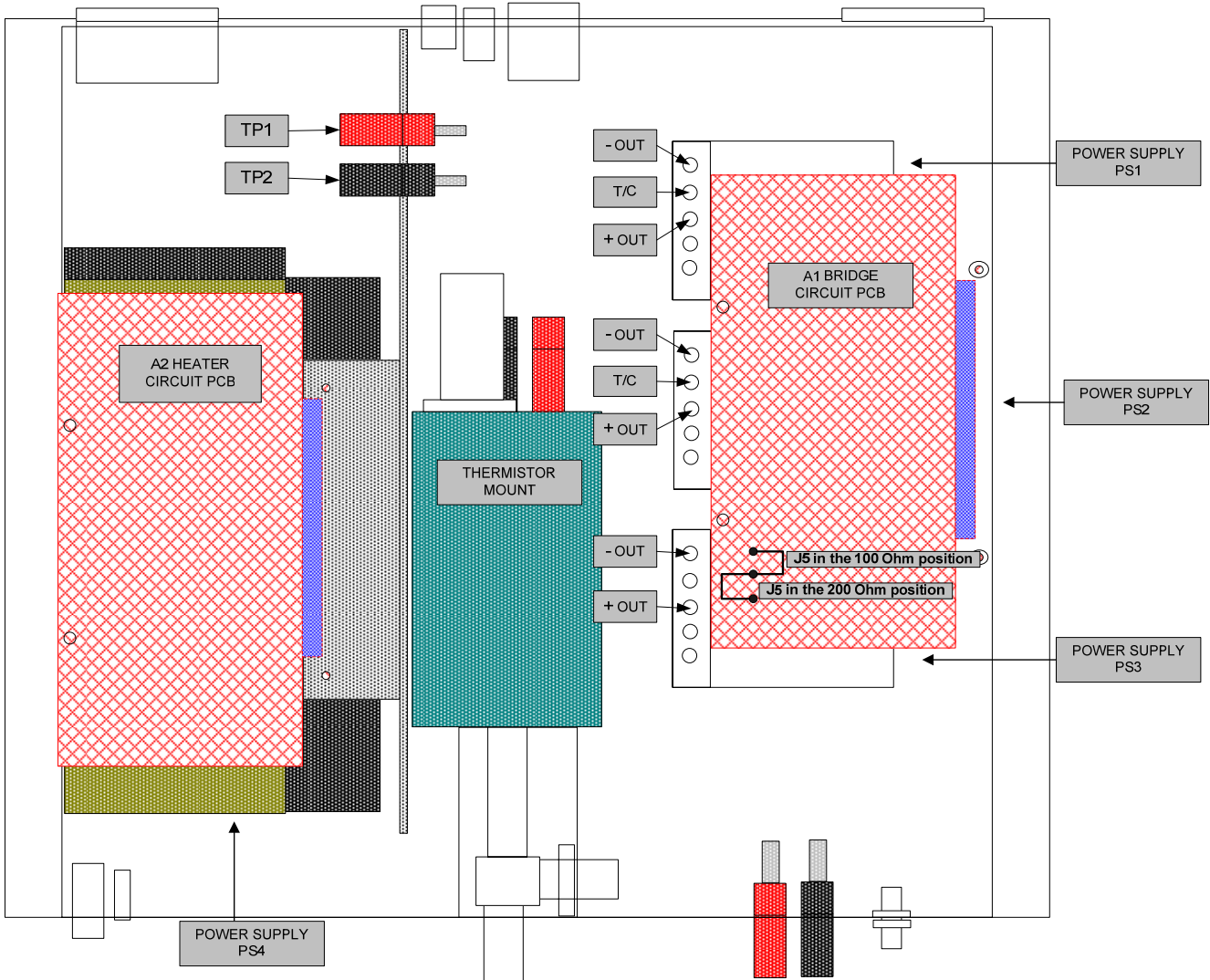

Figure 4.1 Top View layout of Model 1825/1827 subassemblies

Note: All of the Function Tests described in Chapter III of this manual should be performed before performing this Calibration Procedure. If the Model 1825/1827 fails any Calibration procedure and cannot be adjusted, contact TEGAM for assistance. Contact information and instructions for returning an instrument to TEGAM can be found in Chapter V Service Information in this manual.

Remove the Top Cover

If the top cover has not already been removed, remove it to calibrate the Model 1825/1827 to expose the internal assemblies.

1. Remove four screws in rear panel using 9/64" allen wrench.

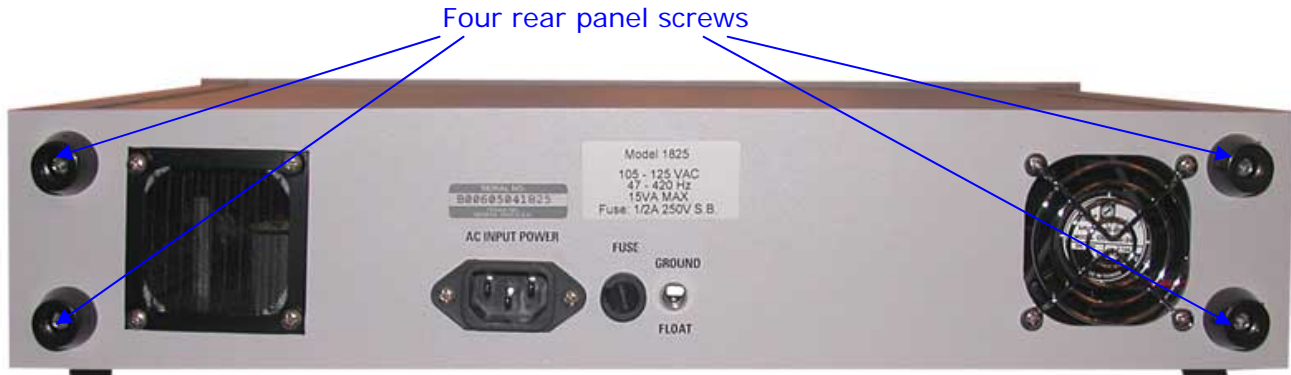



Figure 4.2 Location of four rear panel screws

2. Tilt rear panel down.
3. Slide top cover towards the rear of the unit.



Figure 4.3 Rear panel tilted down

 **Warning:** Many of the procedures described are performed with power applied to the instrument while the protective covers are removed. The electrical energy present at some points may cause personal injury if directly contacted. These procedures should be performed by qualified personnel and caution should be used.

Bridge Board Circuitry Test and Calibration

The bridge board circuitry test checks the Model 1825/1827 bridge board for amplifier offset and provides a calibration of bridge board components. This test uses a Digital Voltmeter (DVM) as a null meter. The DVM should be isolated from ground or battery operated.

1. Ensure the Model 1825/1827 Front Panel Switch is in the OFF position.
2. Disconnect the thermistor mount bias cable spade lugs from the Red Binding Post (TP1) and the Black Binding Post (TP2).
3. Connect the anode of the 1N914 diode to the Model 1825/1827 Red Binding Post (TP1).
4. Connect the cathode of the 1N914 diode to the to the Model 1825/1827 Black Binding Post (TP2).
5. Turn the Model 1825/1827 POWER Switch (S1) to the ON position. Allow the Model 1825/1827 to properly warm up (at least two hours from a completely cold start) and ensure the READY LED is illuminated. Ensure that it is not exposed to drafts, strong light sources, or any other causes of ambient temperature change.
6. Connect the DVM to the Bridge Board PCB (A1) at TP2 and TP5. **Note: ensure that this measurement is not made between TP3 and TP5. Current flow at TP3 will introduce error in this adjustment.**
7. Adjust potentiometer R23 for a $0V \pm 10\mu V$ reading on the DVM.
8. Connect the DVM to the bridge board at TP7 and TP9 and adjust potentiometer R24 for a $0V \pm 10\mu V$ reading on the DVM.
9. Turn the Model 1825/1827 POWER Switch (S1) to the OFF position. Disconnect the 1N914 diode from the Red and Black Binding Posts (TP1 and TP2). Do not reconnect the thermistor mount bias cable spade lugs.

Calibration of Internal Resistance

The internal resistance calibration procedure involves the alignment of several key resistors within the unit. When performing this procedure, ensure that the power is off while making connections.

1. Ensure the Model 1825/1827 Front Panel Switch is in the OFF position.
2. Remove Q7 from the Bridge Board PCB (A1). Use jumpers to connect TP1 on A1 to the junction of R21 and Q6 pin 1.
3. Set the Model 1825/1827 bridge board jumper, J5 to the 100 ohms position (refer to Figure 3.1).
4. Remove the shorting links that are between the Model 1825/1827 Red and Black Binding Post (TP1 and TP2) and the Model 1825/1827 Blue and White Binding Posts (TP3 and TP4).

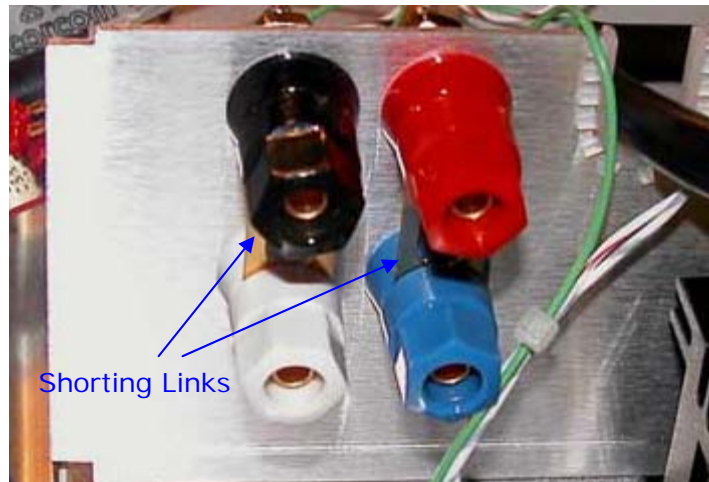

Figure 4.4 Location of shorting links and Red, Black, Blue, and White Binding Posts

5. Connect the four terminal 100-ohm resistance standard between the Model 1825/1827 Red and Black Binding Posts (TP1 and TP2), and the Model 1825/1827 Blue and White Binding Posts (TP3 and TP4), respectively.
6. Connect a DVM with microvolt sensitivity between the bridge board at TP2 and TP5 to act as a null detector.
7. Turn the Model 1825 POWER Switch (S1) to the ON position and allow five minutes for stabilization.
8. Adjust potentiometer R32 for $0V \pm 10\mu V$ reading on the null detector.
9. Turn the Model 1825/1827 POWER Switch (S1) to OFF position.
10. Use a jumper to connect TP8 to the junction of R30 and R33 on the Bridge Circuit PCB (A1).
11. Remove Shorting Plug JP4 from the Bridge Circuit PCB (A1). Set the Model 1825/1827 bridge board jumper, J5 to the 200 ohms position (refer to Figure 3.1).
12. Turn the Model 1825/1827 POWER Switch (S1) to the ON position and allow five minutes for stabilization.
13. Adjust potentiometer R28 for $0V \pm 10\mu V$ reading on the null detector.
14. Turn the Model 1825/1827 POWER Switch (S1) to the OFF position.
15. Re-insert Q7, and JP4.
16. Remove jumpers from between TP8 and the junction of R30 and R33.
17. Remove jumpers from between TP1 and the junction of R21 and Q6 Pin 1.

Power Splitter Calibration

The power splitter calibration characterizes the impedance match of the output port of the Model 1825/1827 and verifies it is within specification. While a Scalar Network Analyzer can be used, TEGAM recommends using a Vector Network Analyzer to measure not only the magnitude but also phase of the reflection coefficient. That data can be used later to apply Gamma corrections to the cal factor of the Model 1825/1827.

1. Ensure the Model 1825/1827 Front Panel Switch (S1) is in the OFF position and remove power cord on the back of the 1825/1827.
2. Disconnect all cables from the Thermistor Mount Assembly inside the Model 1825/1827. Turn the Model 1825/1827 over to remove the bottom cover.
3. Remove bottom cover of the Model 1825/1827 in a similar fashion as the top cover. Tilt rear panel down so it is out of the way. Slide bottom cover towards the rear of the unit.
4. Remove the four philips head screws shown in Figure 4.5 that hold the Thermistor Mount Assembly to the bottom plate of the Model 1825/1827.

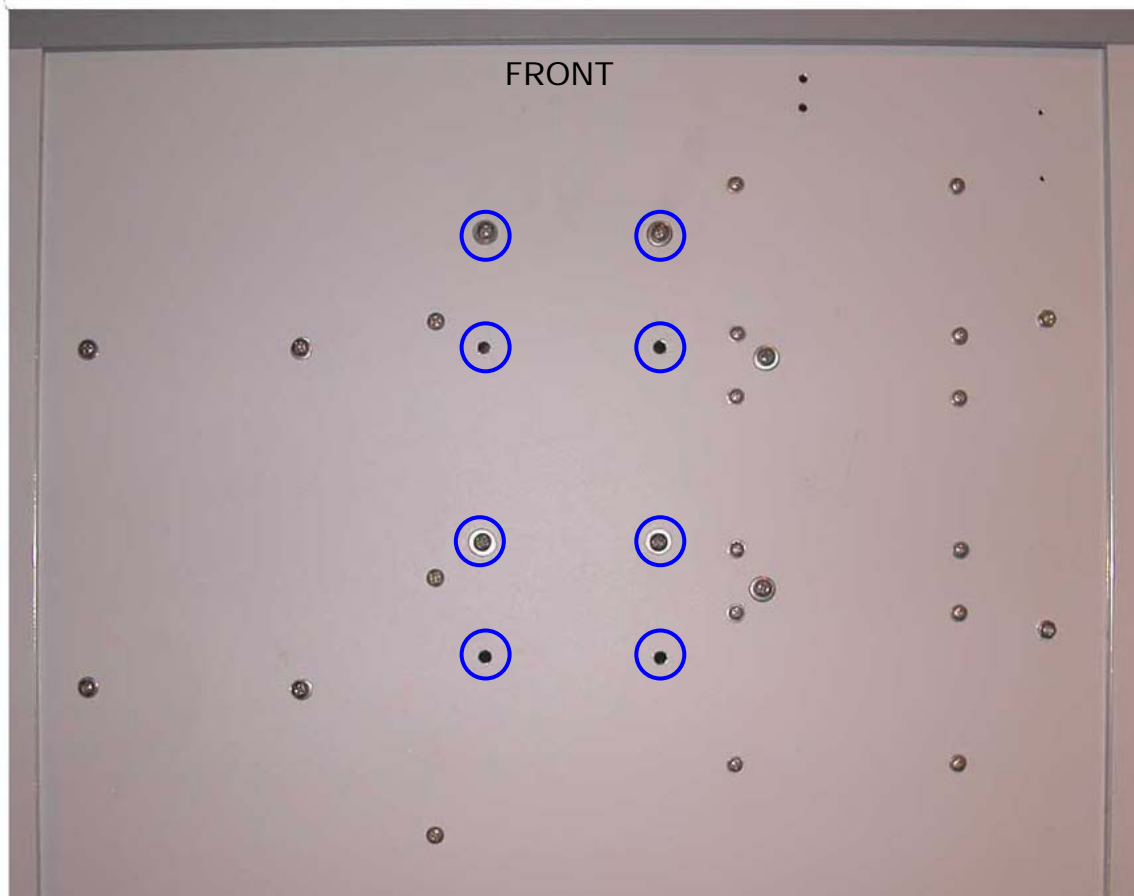

Figure 4.5 Four Screws That Secure the Thermistor Mount to the Model 1825 (circled). The screws in the Model 1827 will be in the other holes circled.

5. Once the Thermistor Mount assembly is removed from the Model 1825/1827, remove the power splitter from the Thermistor Mount. First use a 7/64" allen wrench to remove the two allen head screws that are used to clamp the splitter input to the splitter support bracket. Disconnect the splitter from the N-male connector on the front of the Thermistor Mount.

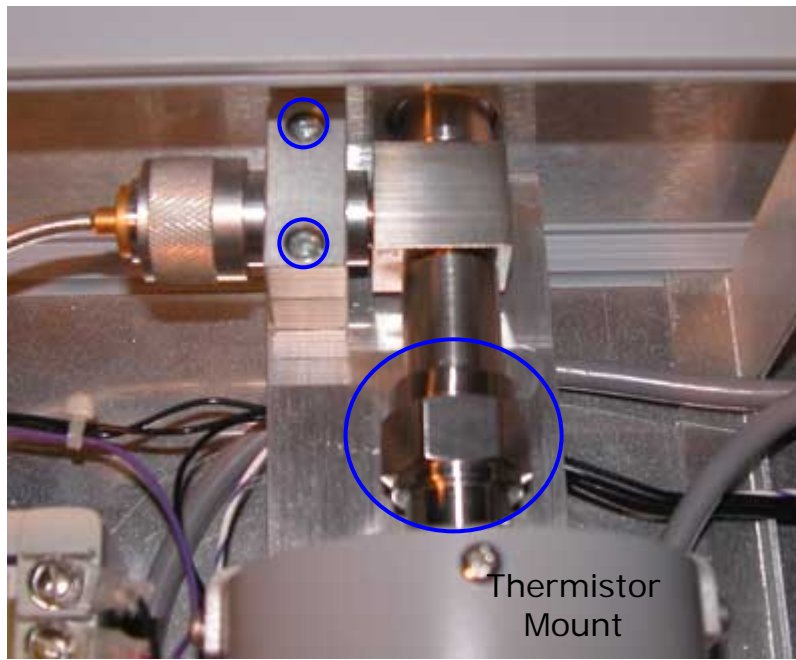

Figure 4.6 Location of two screws used to clamp the power splitter to the splitter support bracket and the type N male connector.

6. Setup and calibrate the Network Analyzer to measure insertion loss and SWR of the power splitter.
7. Terminate Output Port 3 of the power splitter. Connect Input Port 1 and Output Port 2 to the network analyzer to measure insertion loss (S21) (the insertion loss should not exceed 7.5 dB) and the reflection coefficient of Port 2 (S22). Record these measurements for each frequency the Model 1825/1827 will be calibrated.
8. Terminate Output Port 2 of the power splitter. Connect Input Port 1 and Output Port 3 to the network analyzer to measure insertion loss (S31) (the insertion loss should not exceed 7.5 dB) and the reflection coefficient of Port 2 (S33). Record these measurements for each frequency the Model 1825/1827 will be calibrated.
9. Terminate Input Port 1 of the power splitter. Connect Output Port 2 and Output Port 3 to the network analyzer to measure insertion loss (S23). Record these measurements for each frequency the Model 1825/1827 will be calibrated.

10. Calculate the equivalent source match (Γ_2) of the power splitter at each frequency by one of the following equations.

If Port 2 is to be the Output port of the feedthrough standard:

$$\Gamma_2 = S_{22} - ((S_{21}/S_{31}) \times S_{23})$$

If Port 3 is to be the Output port of the feedthrough standard:

$$\Gamma_2 = S_{33} - ((S_{31}/S_{21}) \times S_{32})$$

Note: The preceding steps can be simplified assuming the splitter has good tracking between the output ports, that is S_{21} very nearly equals S_{31} . That would mean the ratio of S_{21} to S_{31} would equal approximately 1, meaning those values would cancel each other out in the equations in step 10. Thus the equivalent source match would equal the measured reflection coefficient of the output port minus the insertion loss between the output ports. Those two measurements can be obtained without changing connections.

11. Record the equivalent source match as the reflection coefficient for the Model 1825/1827.
12. Record the equivalent source match as the reflection coefficient magnitude (ρ) and angle (ϕ), or SWR, at each frequency point. Verify the reflection coefficient magnitude (ρ) is less than 0.065, or the SWR is less than 1.14. (If using SureCal calibration software enter the reflection coefficient in a SureCal .dat file for the 1825/1827).
13. Reassemble the Thermistor Mount Assembly by connecting the splitter to the Thermistor Mount. When connecting the power splitter N female connector to the Thermistor Mount N male connector, make sure both connectors are clean and use the proper torque (12-14 in-lbs). Reassemble the splitter support bracket.
14. Remount the Thermistor Mount assembly to the bottom chassis plate.
15. Replace the bottom cover on the Model 1825/1827 and reconnect all the cables to the Thermistor Mount Assembly.

Thermistor Bias Voltage Calibration

This test verifies the DC bias voltage of the thermistor detector. The DC bias voltage is the voltage across the thermistor detector with no RF signal applied and the bridge circuit balanced and stable.

1. Ensure that the Model 1825/1827 has been on for at least two hours and is properly warmed up with the READY LED is illuminated.
2. Connect the DVM to the red and black BIAS connectors on the back of the back of the thermistor mount. Connect red to positive and black to negative.
3. The voltmeter should read 2.45 +/- 0.03 VDC. If it does not, then the DC bias voltage will have to be adjusted.
4. To adjust the DC bias voltage, locate the small hole in the thermistor mount casing near the back. Remove any cal void stickers if necessary. Remove the plug using a 5/64" Allen wrench

5. Using a small tip screw driver, turn the Bias voltage adjustment. CCW will increase the bias the voltage, CW will decrease it. This must be done very slowly. Only turn the adjustment screw a quarter turn at a time. It will take the bias voltage up to half an hour to settle after on quarter turn adjustment is made.

Calibration Factor

This test characterizes the calibration factor of the Model 1825/1827. The method used is the same as calibrating a power sensor with the Model 1825/1827 (see the Model 1825/1827 Operation Manual), except the sensor is a Primary RF Transfer Standard and the Model 1825/1827 is the Sensor Under Test.

1. Replace the top cover on the Model 1825/1827. The Model 1825/1827 should be fully assembled for the rest of the Calibration.
2. Connect the Primary RF Power Transfer Standard to the Type IV Power Meter in accordance with the operating instructions for that unit. Power on both the Type IV power meter and the Model 1825/1827, allow at least two hours of warm up time before taking any measurements.
3. Connect the Primary RF Power Transfer Standard to the Sensor port of the Model 1825/1827.
4. Connect Signal Source Output to the input of the Model 1825/1827. If two signal sources are used with the Model 1827, connect one signal source to input 1 and the other to input 2. The Input switch is used to switch between the two inputs. Note: Make sure RF connectors are clean and use proper torque wrench to tighten.
5. Connect one voltmeter to the Voltmeter connectors on the Model 1825/1827. Connect the other voltmeter to the voltmeter connectors on the Type IV Power meter.
6. Make sure the output of the signal source is off. Record the DC voltage from the Type IV Power Meter as V_{OFF1} and the DC voltage from the Model 1825/1827 as V_{OFF2} .
7. Set the Signal Source frequency to the first frequency that the Model 1825/1827 will be calibrated at and set the power level for +6 dBm with a Continuous Wave (CW) output. Turn the output of the Signal Source on. Record the DC voltage from each voltmeter after the voltage has settled. Record the DC voltage from the Type IV Power Meter as V_{ON1} and the DC voltage from the Model 1825/1827 as V_{ON2} .
8. Change the frequency of the signal source to the next frequency at which the Model 1825/1827 is to be calibrated. Record the DC voltage from each voltmeter after the voltage has settled as described in Step 7. Repeat this step for each remaining calibration frequency.

9. Calculate the calibration factor for the Model 1825/1827 at each frequency by:

$$K_2 = \frac{V_{\text{OFF}2}^2 - V_{\text{ON}2}^2}{(V_{\text{OFF}1}^2 - V_{\text{ON}1}^2) * K_1}$$

Where:

- K_2 = Calibration factor of the Model 1825/1827,
- $V_{\text{OFF}2}$ = DC voltage from Model 1825/1827 with no RF Power applied,
- $V_{\text{ON}2}$ = DC voltage from Model 1825/1827 with RF Power applied,
- $V_{\text{OFF}1}$ = DC voltage from Type IV Power Meter with no RF Power applied,
- $V_{\text{ON}1}$ = DC voltage from Type IV Power Meter with RF Power applied,
- K_1 = Calibration factor of Primary RF Power Standard.

Gamma Corrections (optional)

This part of the procedure is optional and only applies if the Reflection Coefficient magnitude (ρ) and angle (ϕ) was measured and recorded during the Power Splitter Calibration. The Reflection Coefficient magnitude (ρ) and phase angle (ϕ) must also be known for the Primary RF Power Transfer Standard. Applying Gamma Corrections will provide a more accurate characterization and help reduce uncertainties.

10. Apply Gamma Corrections to the calibration factor of the Model 1825/1827 at each frequency by:

$$\text{Corrected } K_2 = \frac{K_2}{|1 + \Gamma_1 \Gamma_2|^2}$$

Where:

- Corrected K_2 = cal factor of the Model 1825/1827 after Gamma correction are applied,
- K_2 = cal factor of the Model 1825/1827 before Gamma correction is applied,
- Γ_1 = reflection coefficient of the Primary RF Power Transfer Standard,
- Γ_2 = reflection coefficient of the Model 1825/1827

The same formula in terms of magnitude (ρ) and phase angle (ϕ):

$$\text{Corrected } K_2 = \frac{K_2}{(1 - \rho_1 \rho_2 \cos(\phi_1 + \phi_2))^2 + (\rho_1 \rho_2 \sin(\phi_1 + \phi_2))^2}$$

Where:

- Corrected K_2 = cal factor of the Model 1825/1827 after Gamma correction are applied,
- K_2 = cal factor of the Model 1825/1827 before Gamma correction is applied,
- ρ_1 = reflection coefficient magnitude of the Primary RF Power Transfer Standard,
- ϕ_1 = reflection coefficient phase angle of the Primary RF Power Transfer Standard,
- ρ_2 = reflection coefficient magnitude of the Model 1825/1827,
- ϕ_2 = reflection coefficient of the phase angle Model 1825/1827

THEORY OF OPERATION
PREPARATION FOR SERVICE
FUNCTION TESTS
CALIBRATION
SERVICE INFORMATION

Warranty:

TEGAM, Inc. warrants this product to be free from defects in material and workmanship for a period of 1 year from the date of shipment. During this warranty period, if a product proves to be defective, TEGAM, Inc., at its option, will either repair the defective product without charge for parts and labor, or exchange any product that proves to be defective.

TEGAM, Inc. warrants the calibration of this product for a period of 1 year from date of shipment. During this period, TEGAM, Inc. will recalibrate any product, which does not conform to the published accuracy specifications.

In order to exercise this warranty, TEGAM, Inc., must be notified of the defective product before the expiration of the warranty period. The customer shall be responsible for packaging and shipping the product to the designated TEGAM service center with shipping charges prepaid. TEGAM Inc. shall pay for the return of the product to the customer if the shipment is to a location within the country in which the TEGAM service center is located. The customer shall be responsible for paying all shipping, duties, taxes, and additional costs if the product is transported to any other locations. Repaired products are warranted for the remaining balance of the original warranty, or 90 days, whichever period is longer.

Warranty Limitations:

The TEGAM, Inc. warranty does not apply to defects resulting from unauthorized modification or misuse of the product or any part. This warranty does not apply to fuses, batteries, or damage to the instrument caused by battery leakage.

Statement of Calibration:

This instrument has been inspected and tested in accordance with specifications published by TEGAM, Inc. The accuracy and calibration of this instrument are traceable to the National Institute of Standards and Technology through equipment, which is calibrated at planned intervals by comparison to certified standards maintained in the laboratories of TEGAM, Inc.

Contact Information:

TEGAM, INC.
10 TEGAM WAY
GENEVA, OHIO 44041
PH: 440.466.6100
FX: 440.466.6110
EMAIL: sales@tegam.com

Preparation for Repair or Calibration Service:

Once you have verified that the cause for the Model 1825 or 1827 malfunction cannot be solved in the field and the need for repair and calibration service arises, contact TEGAM customer service to obtain an RMA, (Returned Material Authorization), number. You can contact TEGAM customer service via the TEGAM website, www.tegam.com or by calling 440.466.6100 OR 800.666.1010.

The RMA number is unique to your instrument and will help us identify your instrument and to address the particular service request by you which is assigned to that RMA number. Of even more importance is a detailed written description of the problem, which should be attached to the instrument. Many times repair turnaround is unnecessarily delayed due to a lack of repair instructions or lack of a detailed description of the problem.

The detailed problem description should include information such as measurement range, trigger mode, type of components being tested, is the problem intermittent?, when is the problem most frequent?, has anything changed since the last time the instrument was used?, etc. Any detailed information provided to our technicians will assist them in identifying and correcting the problem in the quickest possible manner. Use the Expedite Repair & Calibration form provided on the next page to provide detailed symptoms of the instrument's problem.

Once this information is prepared and sent with the instrument and RMA number to our service department, we will do our part in making sure that you receive the best possible customer service and turnaround time possible.

